

**PFLUGERVILLE**  
**DOWNTOWN EAST PUD**

**EXHIBITS**

*PREPARED BY MCCANN ADAMS STUDIO*  
*June 18, 2024*

**CASE #: PUD2024-00142**

## **DOWNTOWN EAST PUD EXHIBITS**

**Exhibit A: Survey with Metes, Bounds and Field Notes**

**Exhibit B: Zoning Districts**

**Exhibit C: Permitted Use Table**

**Exhibit D: General Regulations**

**Exhibit E: Off-Street Parking Requirements**

**Exhibit F: Downtown East Code Modifications**

**Exhibit G: Signage**

**Exhibit H: Parkland Dedication**

**Exhibit I: City Permitting Process**

**Exhibit J: Downtown East Design Standards**

EXHIBIT A - (PAGE 1)  
**SURVEY WITH METES, BOUNDS AND FIELD NOTES**

Legal Description

**BEING A DESCRIPTION OF A TRACT OF LAND CONTAINING 32.6197 ACRES (1,420,914 SQUARE FEET) OUT OF THE C.S. PARISH SURVEY NO. 2, ABSTRACT NO. 621, AND THE SEFRIM EISELIN SURVEY NO. 1, ABSTRACT NO. 265, BOTH IN TRAVIS COUNTY, TEXAS, AND BEING ALL OF A CALLED 29.075 ACRE TRACT CONVEYED TO THE CITY OF PFLUGERVILLE IN DOCUMENT NO. 2021279186 OF THE OFFICIAL PUBLIC RECORDS OF TRAVIS COUNTY, TEXAS (O.P.R.T.C.T.), AND ALL OF A CALLED 3.54 ACRE TRACT CONVEYED TO THE CITY OF PFLUGERVILLE IN VOLUME 11194, PAGE 1148 OF THE REAL PROPERTY RECORDS OF TRAVIS COUNTY, TEXAS (R.P.R.T.C.T.), SAID 32.6197 ACRES BEING MORE PARTICULARLY DESCRIBED BY METES AND BOUNDS AS FOLLOWS:**



PO Box 90876  
Austin, TX 78709  
512.554.3371  
jward@4wardls.com  
[www.4wardls.com](http://www.4wardls.com)

**BEGINNING**, at a 1/2-inch iron rod found in the west right-of-way line of Farm to Market Road 685 (100' right-of-way), and being in the southeast corner of Lot 48, Block "C" of Willow Creek, Section One, recorded in Volume 84, Pages 1A-1D of the Plat Records of Travis County, Texas (P.R.T.C.T.), and being the northeast corner of said City of Pflugerville 29.075 acre tract, for the northeast corner and **POINT OF BEGINNING** hereof;

**THENCE**, with the west right-of-way line of said FM 685 and the east line of said City of Pflugerville 29.075 acre tract, the following three (3) courses and distances:

- 1) **S27°32'04"W**, a distance of **560.50** feet to a 1/2-inch iron rod with "4Ward Boundary" cap set for an angle point hereof,
- 2) **S27°39'12"W**, a distance of **493.14** feet to a disturbed TxDot Type I concrete monument found for an angle point hereof, and
- 3) **N63°27'11"W**, a distance of **9.89** feet to a TxDot Type II brass disc found for a non-tangent point of curvature hereof, said point being at the beginning of the right-of-way transition from said FM 685 to FM 1825 (E. Pecan Street, right-of-way varies);

**THENCE**, with the right-of-way transition from said FM 685 to said FM 1825, in part with the southeast line of said City of Pflugerville 29.075 acre tract, and in part with the south line of said City of Pflugerville 3.54 acre tract, along the arc of a curve to the right, whose radius is **323.07** feet, whose arc length is **504.73** feet and whose chord bears **S72°29'55"W**, a distance of **454.94** feet to a TxDot Type II brass disc found for an angle point hereof, said point being at the end of the right-of-way transition from said FM 685 to said FM 1825, and being an angle point in the south line of said City of Pflugerville 3.54 acre tract;

**THENCE**, with the north right-of-way line of said FM 1825 and the south line of said City of Pflugerville 3.54 acre tract, **N62°53'26"W**, a distance of **417.37** feet to a calculated point for the southwest corner hereof, said point being at the southeast corner of Lot 1 of the Amended Final Plat of Romans 8:28, recorded in Document No. 201900127 (O.P.R.T.C.T.), and being the southwest corner of said City of Pflugerville 3.54 acre tract, from which a 1/2-inch iron rod in concrete found bears, **S04°28'35"W**, a distance of 0.56 feet;

**THENCE**, leaving the north right-of-way line of said FM 1825, with the common line of said Lot 1 and said City of Pflugerville 3.54 acre tract, the following three (3) courses and distances:

EXHIBIT A - (PAGE 2)  
**SURVEY WITH METES, BOUNDS AND FIELD NOTES**


- 1) **N04°30'47"E**, a distance of **273.86** feet to a 1/2-inch iron rod in concrete found for an angle point hereof,
- 2) **N44°06'23"W**, a distance of **273.97** feet to a 1/2-inch iron rod in concrete found for the northwest corner hereof, and
- 3) **N27°44'13"E**, a distance of **36.47** feet to a 1/2-inch iron rod in concrete found for an angle point hereof, said point being at the common south corner of a reserve lot (for park or playground, drainage easement and P.U.E.) and Lot 28, both of said Block "C" of Willow Creek, Section One;

**THENCE**, with the east and south lines of said Block "C" of Willow Creek, Section One, in part with the west line of said City of Pflugerville 3.54 acre tract, and in part with the west and north lines of said City of Pflugerville 29.075 acre tract, the following three (3) courses and distances:

- 1) **N27°09'15"E**, passing at a distance of 139.42 feet, a calculated point at the common west corner of said City of Pflugerville 3.54 acre tract and said City of Pflugerville 29.075 acre tract, and from which corner, a 1/2-inch iron rod found bears, **S35°55'19"E**, a distance of 0.48 feet, and continuing for a total distance of **264.56** feet to a disturbed 1/2-inch iron rod found for an angle point hereof,
- 2) **N27°37'03"E**, a distance of **735.94** feet to a calculated point (unable to set) for an angle point hereof, and
- 3) **S62°38'38"E**, a distance of **1117.45** feet to the **POINT OF BEGINNING** and containing 32.6197 Acres (1,420,914 Square Feet) of land, more or less.

**NOTE:**

All bearings are based on the Texas State Plane Coordinate System, Grid North, Central Zone (4203); all distances were adjusted to surface using a combined scale factor of 1.000104047266. See attached sketch (reference drawing: 01799\_Title\_CoPf.dwg)

  
5/10/24  
Steven M. Duarte, RPLS #5940  
4Ward Land Surveying, LLC



(S60°04'20"E 1,117.45')  
**S62°38'38"E 1,117.45'**

48

UNABLE TO SET

**P.O.B.**

GRID N: 10,134,289.72  
 GRID E: 3,154,124.06

CALLLED 29.075 ACRES  
 OWNER: CITY OF PFLUGERVILLE  
 DOC. NO. 2021279186  
 O.P.R.T.C.T.

**32.6197 ACRE(S)**  
**1,420,914 SQUARE FEET**

DISTURBED  
 FROM WHICH A  
 1/2" IRON ROD  
 FOUND BEARS  
 S39°55'19"E, 0.48'

IN CONC.

IN CONC.

FROM WHICH A  
 1/2" IRON ROD  
 IN CONCRETE  
 FOUND BEARS  
 S04°28'35"W, 0.56'

APPROXIMATE LOCATION  
 OF SURVEY LINE

**S27°32'04"W 560.50'**  
 (S30°07'20"W 560.55')

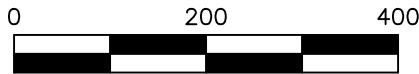
**S27°39'12"W 493.14'**  
 (S30°14'28"W 493.20')

DISTURBED  
 (L1)

**FARM TO MARKET ROAD 685  
 (100' R.O.W.)**

**N62°53'26"W 417.37'**  
 (N60°18'44"W 417.09')

**FARM TO MARKET ROAD 1825  
 (E. PECAN STREET)  
 (R.O.W. VARIES)**



GRAPHIC SCALE: 1" = 200'

**32.6197 ACRES**  
**City of Pflugerville,**  
**Travis County, Texas**



PO Box 90876, Austin Texas 78709  
 INFO@4WARDLS.COM (512) 537-2384  
 TBPELS FIRM #10174300

Date:	5/10/2024
Project:	01799
Scale:	1" = 200'
Reviewer:	SMD
Tech:	DDL
Field Crew:	MW
Survey Date:	MAR. 2024
Sheet:	1 OF 3

EXHIBIT A - (PAGE 4)  
**SURVEY WITH METES, BOUNDS AND FIELD NOTES**

**[A]  
 C.S. PARISH  
 SURVEY NO. 2  
 ABSTRACT NO. 621**


**[B]  
 SEFRIN EISELIN  
 SURVEY NO. 1  
 ABSTRACT NO. 265**

**[C]  
 RESERVED FOR PARK  
 OR PLAYGROUND, DRAINAGE  
 EASEMENT & P.U.E.**

**[D]  
 BLOCK "C"  
 WILLOW CREEK SECTION ONE  
 VOL. 84, PG. 1A-1D  
 P.R.T.C.T.**

**[E]  
 CALLED 3.54 ACRES  
 OWNER: CITY OF PFLUGERVILLE  
 VOL. 11194, PG. 1148  
 R.P.R.T.C.T.**

**[F]  
 AMENDED FINAL PLAT OF ROMANS 8:28  
 DOC. NO. 201900127  
 O.P.R.T.C.T.**

 5/10/2024



**NOTES:**

1. ALL BEARINGS ARE BASED ON THE TEXAS STATE PLANE COORDINATE SYSTEM, GRID NORTH, CENTRAL ZONE, (4203), NAD83, ALL DISTANCES WERE ADJUSTED TO SURFACE USING A COMBINED SCALE FACTOR OF 1.000104047266.
2. SEE ATTACHED METES AND BOUNDS DESCRIPTION.

**32.6197 ACRES  
 City of Pflugerville,  
 Travis County, Texas**



**4WARD**  
 Land Surveying  
 A Limited Liability Company  
 PO Box 90876, Austin Texas 78709  
 INFO@4WARDLS.COM (512) 537-2384  
 TBPELS FIRM #10174300

Date:	5/10/2024
Project:	01799
Scale:	N/A
Reviewer:	SMD
Tech:	DDL
Field Crew:	MW
Survey Date:	MAR. 2024
Sheet:	2 OF 3

EXHIBIT A - (PAGE 5)  
**SURVEY WITH METES, BOUNDS AND FIELD NOTES**

LINE TABLE		
LINE #	DIRECTION	LENGTH
L1	N63°27'11"W	9.89'
L2	N04°30'47"E	273.86'
L3	N44°06'23"W	273.97'
L4	N27°44'13"E	36.47'
L5	N27°09'15"E	264.56'

LINE TABLE {RECORD}		
LINE #	DIRECTION	LENGTH
{L1}	N59°32'00"W	10.10'
{L2}	N04°29'38"E	273.57'
{L3}	N44°04'58"W	273.87'
{L4}	N27°38'51"W	36.37'
{L5}	N29°47'00"E	264.83'

CURVE TABLE					
CURVE #	RADIUS	LENGTH	DELTA	BEARING	DISTANCE
C1	323.07'	504.73'	89°30'45"	S72°29'55"W	454.94'

CURVE TABLE (RECORD)					
CURVE #	RADIUS	LENGTH	DELTA	BEARING	DISTANCE
{C1}	323.07'	505.03'	89°34'00"	S72°24'41"W	455.15'

LEGEND	
———	PROPERTY LINE
- - - - -	ADJACENT PROPERTY LINES
△	CALCULATED POINT
○	1/2" IRON ROD WITH "4WARD BOUNDARY" CAP SET
●	1/2" IRON ROD FOUND (UNLESS NOTED)
■	TXDOT TYPE I CONCRETE MONUMENT FOUND (UNLESS NOTED)
⊙	TXDOT TYPE II BRASS DISC FOUND (UNLESS NOTED)
P.O.B.	POINT OF BEGINNING
VOL./PG.	VOLUME, PAGE
DOC. NO.	DOCUMENT NUMBER
R.O.W.	RIGHT-OF-WAY
P.R.T.C.T.	PLAT RECORDS, TRAVIS COUNTY, TEXAS
R.P.R.T.C.T.	REAL PROPERTY RECORDS, TRAVIS COUNTY, TEXAS
O.P.R.T.C.T.	OFFICIAL PUBLIC RECORDS, TRAVIS COUNTY, TEXAS
(.....)	RECORD INFORMATION FOR DOC. NO. 2021279186
{.....}	RECORD INFORMATION FOR ADJACENT PROPERTIES

**32.6197 ACRES**  
**City of Pflugerville,**  
**Travis County, Texas**

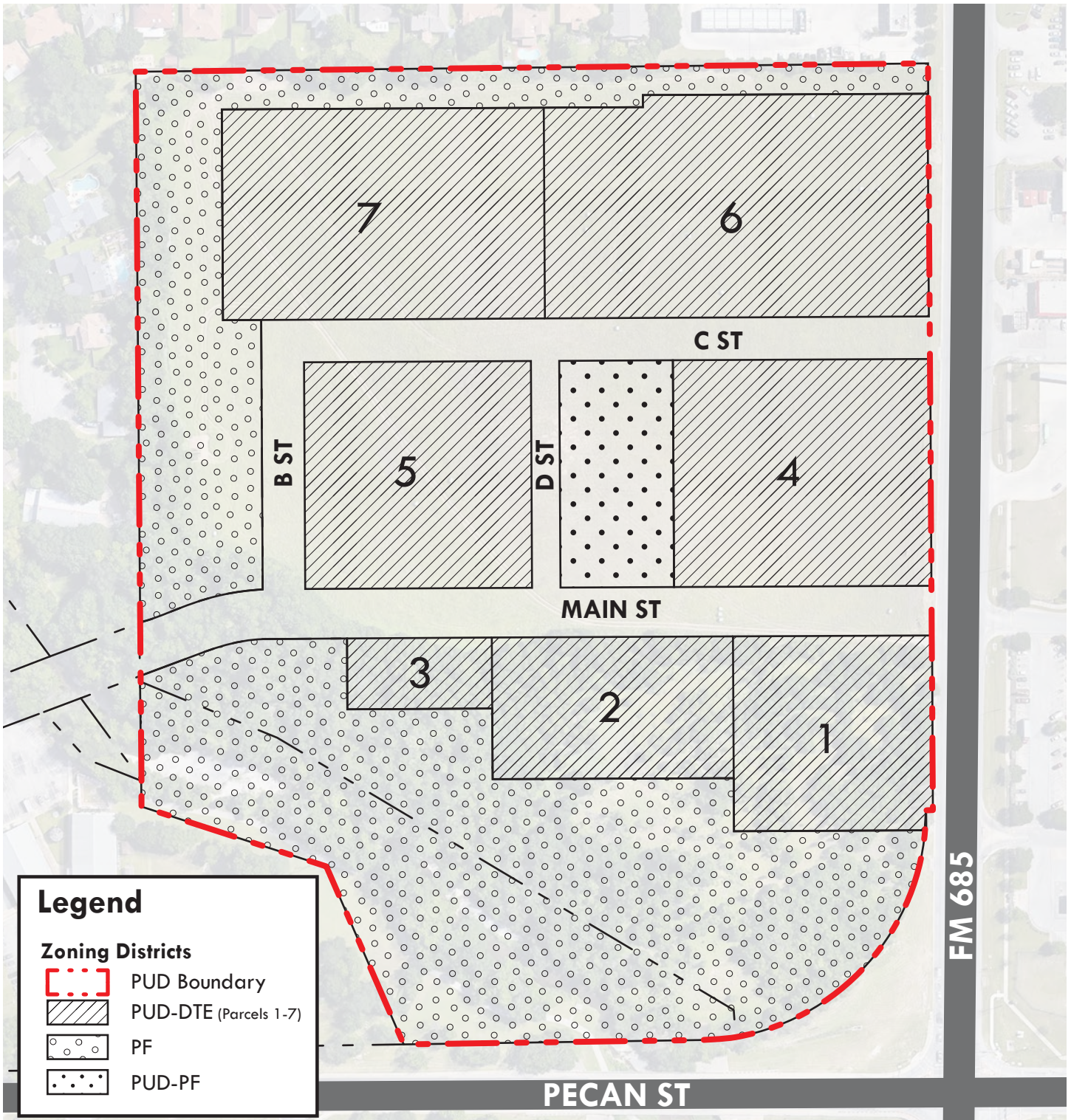


**4WARD**  
*Land Surveying*  
A Limited Liability Company

PO Box 90876, Austin Texas 78709  
 INFO@4WARDLS.COM (512) 537-2384  
 TBPELS FIRM #10174300

Date:	5/10/2024
Project:	01799
Scale:	N/A
Reviewer:	SMD
Tech:	DDL
Field Crew:	MW
Survey Date:	MAR. 2024
Sheet:	3 OF 3

# EXHIBIT B ZONING DISTRICTS



**General Note:**

The requirements of the PUD-DTE and PUD-PF zoning districts supersede the requirements of the Unified Development Code and the Downtown District Overlay, unless otherwise stated within this PUD. The PF district complies with the requirements of the Unified Development Code and the Downtown District Overlay unless otherwise stated within this PUD.



**EXHIBIT C - (PAGE 1)**  
**PERMITTED USE TABLE**

**P= Permitted; C=Permitted with Conditions**

If there is no designation found for a particular use in a specific zoning district, that use is not allowed within that zoning district. In the event that a use is not listed or classification is otherwise required, the Administrator shall classify the use as appropriate in accordance with Subchapter 3 of the Unified Development Code.

RESIDENTIAL USES	PUD-DTE							PUD-PF	CONDITIONS
	PARCEL								
	1	2	3	4	5	6	7		
<b>Multifamily Residential</b>	C				C	P	P		Must be part of a mixed-use development with retail/commercial uses. A multifamily use located on Parcel 5 must have structured parking that serves both residents and district parking needs. The requirements of UDC 4.5.1 and Subchapter 9 are superceded by Exhibits D through J of this PUD.
<b>Live Work Unit</b>	C				C	C	C		Must be located on the ground-floor of a multifamily or mixed-use building. Subject to the requirements of Exhibit J: Design Standards

NON-RESIDENTIAL USES	PUD-DTE							PUD-PF	CONDITIONS
	PARCEL								
	1	2	3	4	5	6	7		
<b>Amenity Center, Private</b>					C	C	C		Must be integrated as part of a multifamily development. Must include a common, on-site open space.
<b>Animal Establishments, Commercial</b>	C			C	C	C	C		Subject to Title 9, Chapter 90
<b>Automotive Parking Lot/Garage</b>	P		P		P	P			
<b>Bar/Tavern</b>	P	P	P	P	P	P	P	C	Temporary Uses require a Temporary Use Permit. Uses occupying a permanent structure require a Specific Use Permit.
<b>Body Art Studio</b>			P	P	P	P	P		
<b>Brewpub/Wine Bar</b>	P	P	P	P	P	P	P	C	Temporary Uses require a Temporary Use Permit. Uses occupying a permanent structure require a Specific Use Permit.
<b>Business Services</b>	P	P		P	P	P	P		
<b>Civic Center</b>	P		P	P	P	P	P	C	Temporary Uses require a Temporary Use Permit. Uses occupying a permanent structure require a Specific Use Permit.
<b>Clinic</b>	P		P	P	P	P	P		
<b>Commercial Recreation and Entertainment, Indoor</b>	P		P		P	P	P		

EXHIBIT C - (PAGE 2)  
**PERMITTED USE TABLE**

NON-RESIDENTIAL USES, CONTINUED	PUD-DTE							PUD-PF	CONDITIONS
	PARCEL								
	1	2	3	4	5	6	7		
Commercial Recreation and Entertainment, Outdoor	P		P		P	P	P		
Day Care Facility	P		P	P	P	P	P		
Event Center	P			P	P	P	P		
Financial Institution	P			P	P	P	P		
Food Processing Establishment, Minor	C				C	C	C		5,000 SF Maximum. Must be accessory to a public-facing retail use.
Government Facilities	P	P	P	P	P	P	P	P	
Health/Fitness Center	C			C	C	C	C		Subject to the conditions of UDC 4.4.3
Hotel/Hotel Residence	C				C	C	C		Subject to the conditions of UDC 4.4.3
Liquor Store (Off-Premise Consumption)	P			P	P	P	P		
Massage Therapy, Licensed	P		P	P	P	P	P		
Mobile Food Park	P		P		P	P	P	P	
Museum/Art Gallery	P	P	P	P	P	P	P		
Office: Administrative, Medical, or Professional	P	P	P	P	P	P	P		
Park or Playground								P	
Personal Services	P		P	P	P	P	P		
Print Shop, Minor	C			C	C	C	C		5,000 SF Maximum. Must have a public-facing retail component
Restaurant	P	P	P	P	P	P	P	C	Temporary Uses require a Temporary Use Permit. Uses occupying a permanent structure require a Specific Use Permit. Drive-thru facilities are not permitted.
Retail Sales and Services	P		P	P	P	P	P	C	Temporary Uses require a Temporary Use Permit. Uses occupying a permanent structure require a Specific Use Permit.
Theatre	P			P	P	P	P		
Transit Terminal (Park & Ride)					P				

EXHIBIT D - (PAGE 1)  
GENERAL REGULATIONS

PUD-DTE (PFLUGER TRACT)							
GENERAL REGULATIONS	PARCEL						
	1	2	3	4	5	6	7
<b>Minimum Lot Area</b>	N/A	N/A	N/A	N/A	N/A	N/A	N/A
<b>Actual Lot Area</b> (subject to change)	1.55 ac	1.56 ac	0.47 ac	2.44 ac	2.35 ac	3.64 ac	3.10 ac
<b>Minimum Lot Width</b>	N/A	N/A	N/A	N/A	N/A	N/A	N/A
<b>Minimum Lot Depth</b>	N/A	N/A	N/A	N/A	N/A	N/A	N/A
<b>Minimum Street Yard Setback from Main &amp; Secondary Streets</b>	5'	5' <sup>1</sup>	5'	5'	5'	5'	5'
<b>Minimum Setback, from FM 685</b> <sup>2</sup> (measured from existing property line)	30'	N/A	N/A	30'	N/A	30'	N/A
<b>Minimum Setback from Pedestrian Street D</b>	N/A	N/A	N/A	N/A	5'	N/A	N/A
<b>Minimum Interior Side Setback</b>	35' <sup>3</sup>	15'	20' <sup>4</sup>	0'	N/A	20' <sup>5</sup>	20' <sup>5</sup>
<b>Minimum Rear Setback</b> <sup>6</sup>	N/A	N/A	N/A	N/A	N/A	N/A	N/A
<b>Minimum Setback from PF zone</b>	0'	0'	10'	N/A	N/A	10'	10'
<b>Minimum Setback from PUD-PF Zone</b>	N/A	N/A	N/A	0' <sup>7</sup>	N/A	N/A	N/A
<b>Maximum Lot Coverage (Structure)</b>	85%	95%	85%	95%	85%	85%	85%
<b>Maximum Impervious Cover</b>	90%	100%	90%	100%	90%	75%	75%
<b>Maximum Building Height</b> <sup>8</sup>	65' <sup>9</sup>	65'	65'	65'	65'	65' <sup>10</sup>	65'
<b>Maximum Building Height within 100' of Single-Family Zoned Site</b>	N/A	N/A	N/A	N/A	N/A	40'	40'
<b>Minimum Residential Density</b>	N/A	N/A	N/A	N/A	N/A	40 du/ac	N/A
<b>Maximum Residential Density</b>	N/A	N/A	N/A	N/A	120 du/ac	120 du/ac	120 du/ac
<b>Minimum Dwelling Unit Area</b>	N/A	N/A	N/A	N/A	450 sq ft	450 sq ft	450 sq ft
<b>Multi-Family Dwelling Unit Mix</b>	Min. 40% 1 Bed / Studio; Max 10% 3+ Bed						

Footnotes:

1. Canopies and columns supporting canopies may encroach into the setback zone of Parcel 2.
2. Existing property line along FM 685 is coterminous with the PUD Boundary at time of final plat approval.
3. Building setback to provide fire lane and trail on west side of Parcel 1
4. Building setback to provide fire lane and trail on east side of Parcel 3
5. Building setback to provide Public Access Easement between Parcels 6 and 7
6. Rear setback is not applicable because all necessary setbacks are provided in this Exhibit.
7. Non-conditioned space (e.g., canopies, balconies and special features) may be permitted to encroach into the Plaza parcel subject to Planning Director approval.
8. Additional height standards are provided in Exhibit J: Downtown East Design Standards, Section 3.2: Building Height and Massing
9. Maximum height is permitted to increase to 85' within 170' of FM 685 Frontage.  
Maximum height of 45' or five (5) floors for parking garage on Parcel 1
10. Maximum height is permitted to increase to 85' within 170' of FM 685 Frontage.  
Maximum height of 65' or seven (7) floors for parking garage on Parcel 6

General Note:

- Covered steps or a covered porch or stoop may project into a required setback up to 3 feet. Bay windows or other architectural projections (either cantilevered or extension of the floor surface) may project into a required setback up to 2 feet.

EXHIBIT D - (PAGE 2)  
**GENERAL REGULATIONS**

**PUD-PF**

**GENERAL REGULATIONS**

<b>Minimum Lot Area</b>	N/A
<b>Actual Lot Area</b> (subject to change)	1.18 ac
<b>Minimum Lot Width</b>	N/A
<b>Minimum Lot Depth</b>	N/A
<b>Minimum Street Yard Setback from Main &amp; Secondary Streets</b>	5'
<b>Minimum Setback from Pedestrian Street D</b>	5'
<b>Minimum Side Street Setback (Corner Lot)</b>	N/A
<b>Minimum Interior Side Setback</b> (Adjacent to Parcel 4)	25'
<b>Maximum Lot Coverage (Structure)</b>	20%
<b>Maximum Impervious Cover</b>	30% <sup>1</sup>
<b>Maximum Building Height</b>	25'

*Footnote:*

1. Assumes artificial turf area is designed to be pervious

## EXHIBIT E

# OFF-STREET PARKING REQUIREMENTS

The following off-street parking requirements for the PUD-DTE zoning district shall supersede the requirements of Chapter 10.4.6 of the UDC:

- (1) A District Parking Plan shall be adopted and approved by the City of Pflugerville to define the amount of parking required to serve Parcels 1-5 within the PUD-DTE Zone, as shown on Exhibit B. The District Parking Plan will supersede the parking requirements of Chapter 10.4.6 of the UDC and shall incorporate a Shared Parking Plan utilizing the Urban Land Institute (ULI)/National Parking Association (NPA) methodology. The District Parking Plan shall be revised for each increment or phase of development. If the Planning Director determines that parking deficiencies from previous development phases exist, additional parking may be required in subsequent phases.
  - (2) In addition to the Parking Dimensions provided in Table 10.4.8 of the UDC, 90-degree angle parking spaces may use the following alternative dimensions:
    - a. Width of Stall: 8'-6"
    - b. Length of Stall: 17'-6"
    - c. Width of Two-Way Aisle: 25'-0"
  - (3) Up to 15% of the required parking may be provided with compact spaces. The minimum dimensions for compact 90-degree angle parking spaces are as follows:
    - a. Width of Stall: 7'-6"
    - b. Length of Stall: 15'-0"
    - c. Width of Two-Way Aisle: 18'-0"
  - (4) Bicycle parking shall be provided in accordance with Subchapter 10.7 of the Unified Development Code.
  - (5) Parking for non-residential uses within the PUD-DTE zoning district may be located off-site anywhere within that district. Community and shared parking facilities are encouraged.
  - (6) At the discretion of the City Engineer and Planning Director, on-street parking may count towards the total required parking for the District Parking Plan.
  - (7) For uses not included within the District Parking Plan, the following parking ratios shall apply:
    - a. Multi-Family:
      - i. Studios – 0.85 spaces per unit
      - ii. 1-bedroom - 0.90 space per unit
      - iii. 2-bedroom - 1.65 spaces per unit
      - iv. 3+ bedrooms - 2.50 spaces per unit
    - b. Live-Work: 2 per unit (1 resident, 1 visitor, may be provided in tandem)
    - c. Business Services: 3.33 spaces per 1,000 square feet of gross floor area
    - d. Clinic: 4 spaces per 1,000 square feet of gross floor area
    - e. Office: Administrative or Professional – 3 spaces per 1,000 square feet of gross floor area
    - f. Office: Medical - 4 spaces per 1,000 square feet of gross floor area
    - g. Retail Sales and Services: 3.33 spaces per 1,000 square feet of gross floor area
    - h. Brewpub/Wine Bar: 10 spaces per 1,000 square feet of gross leasable area
    - i. Hotel: 0.80 spaces per key, 8 spaces per 1,000 square feet of restaurant/lounge/bar spaces, 12 spaces per 1,000 square feet of meeting/banquet space
    - j. Health Club/Gym/Athletic Studio: 7 spaces per 1,000 square feet of gross leasable areaAlternatively, uses not included within the District Parking Plan are encouraged to join the Plan by submitting an amended District Parking Plan and parking study demonstrating that a combination of proposed on-site parking plus available district parking can accommodate the proposed uses.
- (8) Refer to Exhibit J: Downtown East Design Standards Sections 3.8 and 3.9 for additional parking requirements.

EXHIBIT F - (PAGE 1)  
**DOWNTOWN EAST CODE MODIFICATIONS**

**City of Pflugerville Unified Development Code**

<b>CODE SECTION</b>	<b>SUBJECT</b>	<b>ITEM TO BE MODIFIED</b>	<b>MODIFICATION</b>
4.5.1	Downtown District Overlay	Exemption of the requirements of the Downtown District Overlay in order to allow for the specific development and streetscape requirements needed for the Downtown East District	Superseded by the requirements of this PUD
9	Architectural, Site Design and Layout Provisions	Exhibits D and J of this PUD provide the necessary architectural, site design and layout provisions for the Downtown East District	Superseded by the requirements of this PUD
10.4.3	Surfacing	To allow temporary/interim parking lots to utilize alternative surfacing materials other than asphalt and Portland cement binder pavement.	Superseded by PUD Exhibit J: Design Standards Section 3.9
10.4.6	Parking Requirements	Exhibit E provides for a district parking program to be prepared at each increment of development to allow for shared parking for City Hall, Recreation Center, Civic Plaza and retail/restaurant uses. Exhibit E also provides minimum parking standards for uses not included in the district parking program.	Superseded by PUD Exhibit E
10.4.8.A.B	Parking Space Dimensions	For greater flexibility, Exhibit E provides alternative parking space dimension requirements.	Superseded by PUD Exhibit E
10.4.8.B	Parking Lot Setback Adjacent to ROW	This code requires that a maximum of 7 contiguous spaces be allowed without a separated landscape island for parking lots within 20' of ROW. To provide the amount of parking needed for Phase 1, the Downtown East District is exempted from this requirement.	Superseded by PUD Exhibit J: Design Standards Section 3.9
11.3, 11.5 - 11.10	Landscaping and Screening Standards	To ensure the viability of the proposed street designs and temporary parking lot options, greater flexibility is required for landscaping and screening standards	Superseded by PUD Exhibit J: Design Standards Chapter 3
11.11.2	Tree Spacing from Utilities and Impervious Cover	Street trees within the Downtown East District shall be planted 4' from back-of-curb, but will be permitted to be planted less than 4' from a sidewalk subject to Exhibit J Section 5.3	Superseded by PUD Exhibit J: Design Standards Section 5.3
15.16.9	Easements	A ten (10) foot public utility easement is not being provided adjacent to all public street frontages. All utilities are being placed within the ROW to maximize the development parcel areas.	Superseded by Exhibit J: Design Standards Section 5.9

EXHIBIT F - (PAGE 2)  
**DOWNTOWN EAST CODE MODIFICATIONS**

**City of Pflugerville Engineering Design Manual and Construction Standards**

<b>CODE SECTION</b>	<b>SUBJECT</b>	<b>ITEM TO BE MODIFIED</b>	<b>MODIFICATION</b>
Section 2, DG2.1.C - Table 2.1, DG2.3.1	Street Design Requirements	ROW Width, Pavement Width, Curve & Curb Return Radii, Speed requirements for Urban Main Street, B Street and C Street, as well as requirements for angled parking.	Superseded by PUD Exhibit J: Design Standards (Chapter 5: Streetscape)
Section 2, DG2.1.D	Pavement Section Relationship to ROW Centerline	Pavement section must be along ROW centerline.	Variance required for Main Street bridge crossing if 12" shared use path and 8" pedestrian sidewalk are to be required on north and south side of pavement, respectively.
Section 3, DG3.0.F	Pedestrian and Bicycle Facilities	Pedestrian sidewalks to be constructed in conformance with current City Standard Details. Variance needed for pavers or decorative pavements along Main Street. Need variance from Downtown Overlay standards as there is no City Standard Detail for decorative pavement.	Superseded by PUD Exhibit J: Design Standards (Chapter 5: Streetscape)
Section 4, DG4.0.E	Regional Stormwater Management Facility Participation	The project is not providing onsite stormwater detention storage to mitigate the increase in runoff from the site since it will not increase the peak flow in Gilleland Creek at the downstream point of the property.	The project will not increase peak flow in Gilleland Creek at the downstream point of the property.
Section 4, DG4.4.C	Location of Storm Sewer in Street	Requires public storm sewer to be offset by minimum of 5' from road centerline and wastewater to be offset the same amount on other side. This section allows alternate location of pipe at discretion of City Engineer.	Deviation allowed at the discretion of the City Engineer.
Section 5, DG5.1.I.	Minimum Vertical Separation from All Other Utilities, Minimum Depth of Bury	Required minimum vertical separation of 18" from all other utilities may not be easy to achieve at some intersections. Request to change this separation to 12" or add revision to allow less separation at discretion of City Engineer. A proposed water line is to be constructed bolted to proposed Main Street bridge per recommendation from City Utility Department.	Deviation allowed at the discretion of the City Engineer.
Section 6, DG6.0.G.	Wastewater Easement Width	Requirement for wastewater easement to be twice the depth of wastewater line. Revise to allow variance at discretion of City Engineer.	Deviation allowed at the discretion of the City Engineer.

EXHIBIT F - (PAGE 3)  
**DOWNTOWN EAST CODE MODIFICATIONS**

**City of Pflugerville Tree Technical Manual**

<b>CODE SECTION</b>	<b>SUBJECT</b>	<b>ITEM TO BE MODIFIED</b>	<b>MODIFICATION</b>
2.5	Activities During Construction & Demolition Near Trees	Provide additional flexibility for construction in the vicinity of existing trees.	Allow use of a pneumatic soil excavation tool within tree CRZ for remediation of heavily compacted soils and / or installation of utilities or piers (for low-impact deck or boardwalk supports).
3.4	Minimum distance from trees to curb, sidewalk, or driveway:	Where trees (any size) may be proposed less than four feet from walks or curbs, soil cells or structural soils will be required beneath adjacent pavements within a radius of 15 feet from the center of the tree.	Allow exception for 4-foot tree clearance with noted mitigation. Exceptions can be made near walkways and on-street parking, as described in the notes. However, no exceptions can be made along roadways, fire lanes, or service driveways to limit pruning frequency and conflict with tall vehicles by direction of the City Forester.
3.4.2 a.	Minimum distance between newly planted trees:	Where trees (any size) may be proposed less than 40 feet apart from another, a contiguous tree trench will be required along with soil cells or structural soils beneath adjacent pavements within a radius of 15 feet from the center of the tree.	Allow exception for tree spacing rule with noted mitigation.
3.5.3	Miscellaneous materials	Section lists acceptable materials	Allow subsurface tree rootball staking or guying in addition to materials listed in Section 3.5.3.
3.5.3	Miscellaneous materials	Section lists acceptable materials	Allow alternate above-grade guying, such as soft polypropylene webbing, in addition to materials listed in Section 3.5.3.
3.10	Maintenance Responsibility	Where trees (any size) may be proposed less than 30 feet from structures or less than 25 feet from street lights, the property owner association will be responsible for long term preventative maintenance including structural pruning of the tree canopy to prevent conflict with adjacent structures.	Supervision of an ISA Certified Arborist or higher (BCMA, RCA) shall be required for maintenance activities.



EXHIBIT G - (PAGE 1)

**SIGNAGE**

*General Note:*

*Amendments specifically referenced in this exhibit shall apply to the PUD-DTE zoning district as noted.*

*All other aspects of the City of Pflugerville Sign Code (City of Pflugerville Code of Ordinances §154) will apply.*

**Table C1**

Permitted Signs by Type in the PUD-DTE Zoning District

<b>Permitted Sign Type</b>	<b>PUD-DTE AREAS (PFLUGER TRACT)</b>
Residential Use	N/A
Monument	-
Low-Profile Pole Sign	-
Temporary	P
Building Marker	A
Canopy and Awning	P
Marquee	-
Projecting	P
Residential	N/A
Suspended	P
Wall	P
Wall (Mural)	A
Window	A
Banner	P
Commercial Flag	-
Non-Commercial Flag	A
Portable	A
Electronic Message Center (EMC)	-
Changeable Copy	P
Illumination, Internal	-
Illumination, External	P
Illumination, Exposed Bulbs	P
Illumination, Exposed Neon	P

*Footnotes:*

- a) Refer to Pflugerville UDC Section 154.302(E) for Temporary Sign regulations.

*General Notes:*

- A = Allowed without sign permit, provided it complies with the conditions of the City of Pflugerville Code of Ordinances, § 154.300 et seq.
- P = Allowed only with a sign permit.
- Blank = Not Permitted

EXHIBIT G - (PAGE 2)

**SIGNAGE**

**Table C2**

Maximum Total Sign Area per Lot in the PUD-DTE Zoning District

The maximum total area of all signs on a lot except incidental, building marker, Mural, and Non-Commercial Flags shall not exceed the lesser of the following:	
<b>Permitted Sign Type</b>	<b>PUD-DTE AREAS</b> (PFLUGER TRACT)
Maximum number of total square feet	800 S.F. <sup>a</sup>

Footnotes:

- a) Murals created through the Art in Public Places program do not count towards the maximum total sign area.

General Note:

For buildings with ground-floor retail uses, each tenant is allowed to install window signs and one of the following permitted sign types:

- Canopy/awning, projecting sign, wall sign, or suspended sign.

provided each sign complies with the individual sign size limits described in Table C4 and that the maximum total area of all signs on a lot do not exceed the limit described in Table C2.

**Table C4**

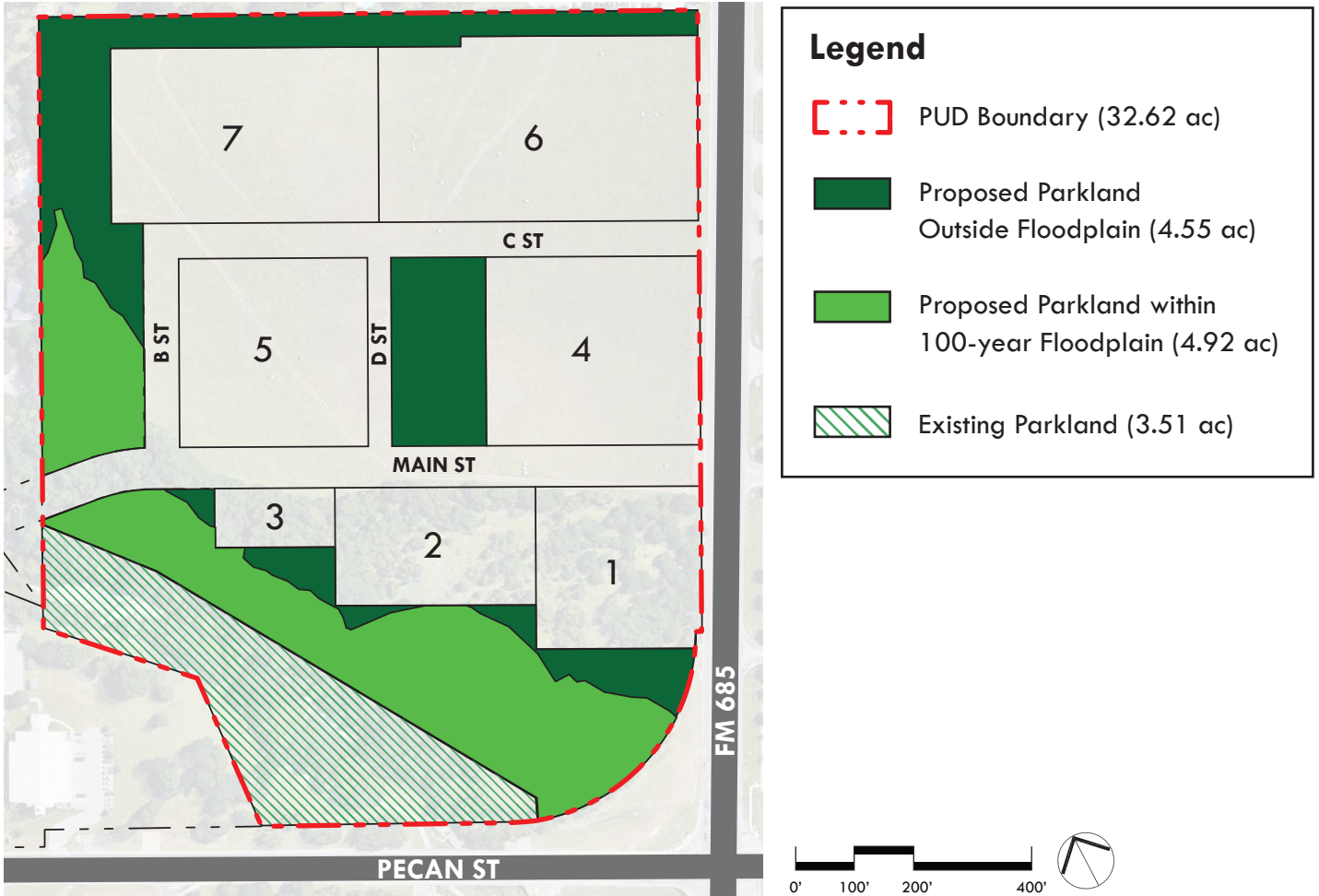
Dimensions of Individual Ground-Floor Retail Signs in the PUD-DTE Zoning District

<b>Permitted Sign Type</b>	<b>Sign Size Limit</b>
Wall Sign	Maximum 1 S.F. per linear foot of storefront frontage, defined by limits of tenant lease line (e.g. a 20'-wide storefront may have a sign up to 20 S.F.).
Projecting and Suspended Sign <sup>a</sup>	Maximum 0.25 S.F. per linear foot of storefront frontage, defined by limits of tenant lease line (e.g. a 20'-wide storefront may have a sign up to 5 S.F.).
Window Signs	See Pflugerville Code of Ordinances § 154.302(D)(6) Window Signs.

Footnotes:

- a) Sign dimensions are subject to the clearance requirements of City of Pflugerville Code of Ordinances § 154.301(E) Sign Clearance.

## EXHIBIT H PARKLAND DEDICATION



### Calculation of Parkland Dedication Requirement (UDC 14.3.2)

$$\text{Number of Units} = \frac{1000 \text{ (Acres to be Dedicated as Parkland)}}{6.6 \text{ (Persons per Unit)}}$$

$$\text{Number of Units} = \frac{1000 \text{ ((Acres Outside Floodplain)+(0.5*Acres Inside Floodplain))}}{6.6 \text{ (Persons per Unit)}}$$

$$\text{Number of Units} = \frac{1000 \text{ ((4.55 ac)+(0.5*4.92))}}{6.6 \text{ (2)}}$$

**Number of Units = 531**

### Park Development Fee (UDC 14.4)

The Downtown East PUD will be subject to the Park Development Fee.

Anticipated residential development will exceed 25 dwelling units per acre.

Therefore, residential developments will be subject to the \$496 per dwelling unit

Park Development Fee, per Table 14.4.2 of the UDC.

EXHIBIT I - (PAGE 1)  
**CITY PERMITTING PROCESS**

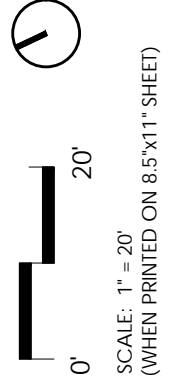
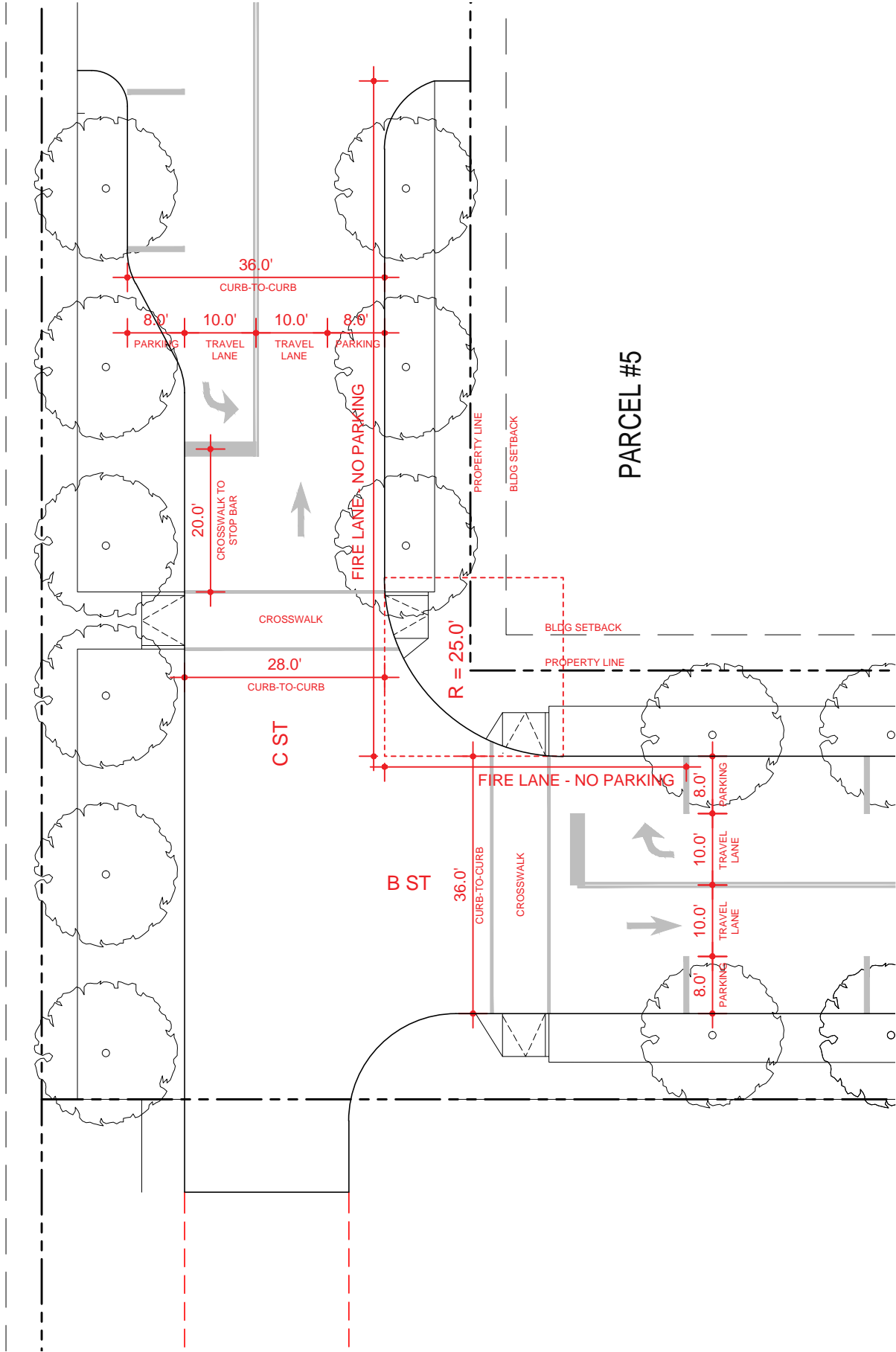
**Building Permits**

Development within Downtown East will comply with the International Building Code as adopted City of Pflugerville. The Building Official may permit a phased approach for building permits within Phase One only.

**Fire Review**

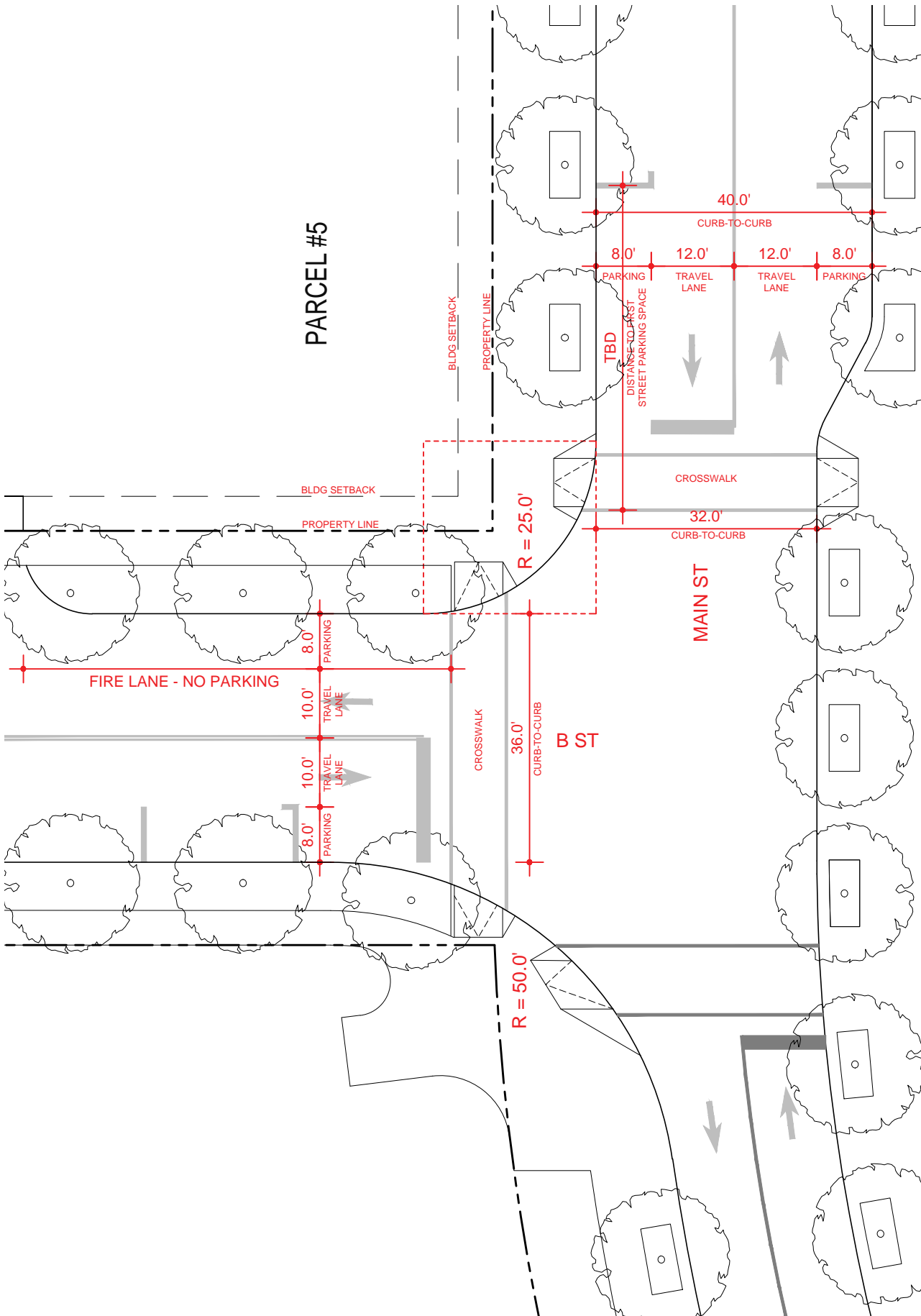
Development within Downtown East will comply with the International Fire Code as adopted by the City of Pflugerville. The following diagrams (on pages 2 and 3 of this Exhibit) provide illustrations of how two of the key intersections within Downtown East could be configured to meet the requirements of the Code.

EXHIBIT I - (PAGE 2)  
**CITY PERMITTING PROCESS**



**For Illustrative Purposes Only**  
**Fire Access Dimensions - C St at B St Intersection**  
**Pflugerville Downtown East**  
 Prepared by McCann Adams Studio for Griffin | Swinerton  
 Draft 05.22.2024

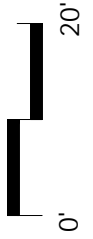
EXHIBIT I - (PAGE 3)  
**CITY PERMITTING PROCESS**



*For Illustrative Purposes Only*  
**Fire Access Dimensions - Main St at B St Intersection**  
**Pflugerville Downtown East**

Prepared by McCann Adams Studio for Griffin | Swinerton

Draft 05.22.2024



SCALE: 1" = 20'  
 (WHEN PRINTED ON 8.5"x11" S)

# Downtown East Design Standards

JUNE 18, 2024







EXHIBIT J:

# Downtown East Design Standards

June 18, 2024



# TABLE OF CONTENTS

## 1. INTRODUCTION

1.1 BACKGROUND.....	3
1.2 THE VISION AND GUIDING PRINCIPLES.....	4
1.3 PLANNING CONTEXT.....	5
1.4 ORGANIZATION OF THE DESIGN STANDARDS.....	7

## 2. THE PLAN FOR DOWNTOWN EAST

2.1 PLAN ELEMENTS.....	10
2.2 THE REGULATING & PARCEL PLANS.....	13
2.3 ILLUSTRATIVE MASTER PLAN & SCENARIOS.....	14

## 3. BUILDING FORM AND DEVELOPMENT STANDARDS

3.1 LOCATION OF USES.....	28
3.2 BUILDING HEIGHT & MASSING.....	29
3.3 BUILDING PLACEMENT.....	32
3.4 PEDESTRIAN-PRIORITY FRONTAGE REQUIREMENTS.....	33
3.5 PEDESTRIAN-FRIENDLY FRONTAGE REQUIREMENTS.....	33
3.6 NEIGHBORHOOD BUFFER / GREENBELT FRONTAGE REQUIREMENTS.....	34
3.7 GENERAL FRONTAGE REQUIREMENTS.....	34
3.8 PARKING GARAGES.....	35
3.9 SURFACE PARKING LOTS.....	36
3.10 SERVICE AND LOADING.....	37
3.11 SITE LANDSCAPING.....	37

## 4. BUILDING DESIGN STANDARDS

4.1 BUILDING DESIGN PRINCIPLES.....	40
4.2 BUILDING FORM AND FACADE VARIATION.....	42
4.3 PARKING GARAGE TREATMENTS.....	43
4.4 CORNER AND TERMINUS ELEMENTS.....	43

4.5 GROUND LEVEL RESIDENTIAL.....	43
4.6 GROUND-LEVEL COMMERCIAL AND “RETAIL-READY” TREATMENT.....	44
4.7 BUILDING MATERIALS.....	45
4.8 ROOF TREATMENT.....	45

## 5. STREETScape DESIGN STANDARDS

5.1 STREETScape DESIGN PRINCIPLES.....	48
5.2 STREET NETWORK & CROSS-SECTIONS.....	48
5.3 STREET TREES.....	53
5.4 SIDEWALK AND PAVING TREATMENT.....	58
5.5 TIMING AND RESPONSIBILITIES FOR STREETScape.....	60
5.6 DRIVEWAYS AND CURB CUTS.....	61
5.7 STREET LIGHTING.....	61
5.8 STREET FURNISHINGS.....	62
5.9 OUTDOOR CAFE ZONES.....	64
5.10 SERVICES AND UTILITIES.....	66
5.11 PUBLIC ART.....	66

## 6. OPEN SPACE DESIGN STANDARDS

6.1 OPEN SPACE DESIGN PRINCIPLES.....	70
6.2 PARKS AND OPEN SPACE.....	72
6.3 VEGETATIVE BUFFER YARD AND SCREENING.....	72
6.4 GREENBELT & TRAIL SYSTEM.....	74
6.5 RECOMMENDATIONS TO IMPROVE THE ECOLOGICAL HEALTH OF THE GREENBELT.....	78
6.6 CIVIC PLAZA.....	79

## APPENDIX

### APPENDIX A: Pflugerville Civic Center Preliminary Parking Needs Analysis Summary by Walker Consultants

#### LIST OF TABLES

Table 1: Phase 1 District Parking - Projected Demand	17
Table 2: Development Program Options and Parking Demand	26

#### LIST OF FIGURES

Figure 1: Project Area Map	2
Figure 2: Vicinity Map	3
Figure 3: Downtown East Regulating Plan	12
Figure 4: Phase 1 Illustrative Plan	14
Figure 5: Full Build-Out Illustrative Plan	15
Figure 6: Parcel 1 - Development Options	18
Figure 7: Parcel 3 - Development Options	19
Figure 8: Parcel 5 - Early-Term Development Option	20
Figure 9: Parcel 5 - Development Options	20
Figure 10: Parcels 6 & 7 - Development Options	23
Figure 11: Illustrative Phasing Concept	24
Figure 12: Height Diagram	29
Figure 13A: Height/Step-back in Relation to Single-Family Homes along Cedar Ridge Drive	30
Figure 13B: Height/Step-back in Relation to Single-Family Homes along Meadow Creek Drive	31
Figure 14: Building Placement	32
Figure 15: Building Frontage Requirements	33
Figure 16: Parking Garages	35
Figure 17: Interim Parking Lot Design Concept	36
Figure 18: Ground Level "Retail Ready" Treatment	44
Figure 19: Key Map of Street Cross-Sections	48
Figure 20: Cross-Sections of Main Street	49
Figure 21: Cross-Sections of Secondary Streets	50
Figure 22: Cross-Section of the Civic Plaza Promenade	51

Figure 23: Cross-Section of the FM 685 Frontage	51
Figure 24: Fire Access Diagram	52
Figure 25: Street Tree Map	54
Figure 26: Proposed Street Tree Species	55
Figure 27: Street Tree Planting Detail	57
Figure 28A: Main Street, East of B Street	58
Figure 28B: Main Street, West of B Street	58
Figure 29: B & C Streets	59
Figure 30: Civic Plaza Promenade	59
Figure 31: Main Street Outdoor Cafe Zone	64
Figure 32: Trail Alignment Diagram	75
Figure 33: Trail Concept Sections	76
Figure 34: Civic Plaza Concept Plan	80



# 1

## Introduction

As Pflugerville and its surrounding region continue to grow, so has interest in revitalizing and expanding the City's historic downtown. Through the implementation of the 28-acre "Downtown East" project, the City seeks to strengthen its civic presence by creating a vibrant new district space for residents and visitors. In pursuit of this vision, the City of Pflugerville has taken the steps described below to set the stage for this compelling development.



Figure 1: Project Area Map

## 1.1 BACKGROUND

**Downtown Action Plan:** In 2018, the City adopted the Downtown Action Plan (DAP), which defines the key steps and projects necessary to revitalize downtown. Efforts include utility and drainage studies, zoning and code amendments and the expansion of Downtown eastward into previously undeveloped land.

**Assembly of Key Properties and Amendment of Tax Increment Reinvestment Zone (TIRZ) No. 1:** In 2021, the City acquired the “Pfluger Tract” – 29 acres of mostly agricultural land located just east of the historic Downtown – with the goal of creating a civic center with a new City Hall and Recreation Center, to be supported by adjacent mixed-use development. Since then, the City is negotiating with property owners to provide for the extension of Main Street eastward from Downtown to FM 685 through the center of the Pfluger Tract. In 2022, the City amended their Downtown TIRZ to encompass the Pfluger Tract, providing a critical funding tool for the Downtown East project.

**Selection of a Development Partner and Preparation of the Concept Master Plan:** Through a competitive solicitation process, the City selected Griffin|Swinerton as its developer partner to design and construct the public facilities and the infrastructure to support the Downtown East project. As part of the Exclusive Negotiation Agreement (ENA) between the City and Griffin|Swinerton, a concept master plan was created with community participation to establish the overall vision for the District and to plan and program the public facilities.

**Rezoning of the Site:** To allow the vision for Downtown East to be achieved, the City of Pflugerville has created a Planned Unit Development (PUD) zoning district. The PUD district provides the regulatory flexibility needed to allow for the different uses and building types proposed within the Downtown East site. The Downtown East Design Standards supplement the PUD zoning ordinance by providing standards for buildings, streetscapes and open spaces within the Downtown East district.

**City Hall and Recreation Center:** Anchoring Downtown East will be two major civic facilities: a City Hall and a Recreation Center - each designed to meet the needs of this rapidly growing community and to activate the proposed Civic Plaza. Architects have been selected to design each of the buildings, and their designs have been developed in concert with the preparation of these design standards.

The intent of these Design Standards is to provide clear direction for the City, its development partners and current and future designers to implement the community’s vision for Downtown East. The standards and guidelines are intended to establish a flexible yet consistent urban design framework for future development within the District. All applicable regulations in the Unified Development Code (UDC) shall apply, to the extent that such regulations do not conflict with those within this exhibit.

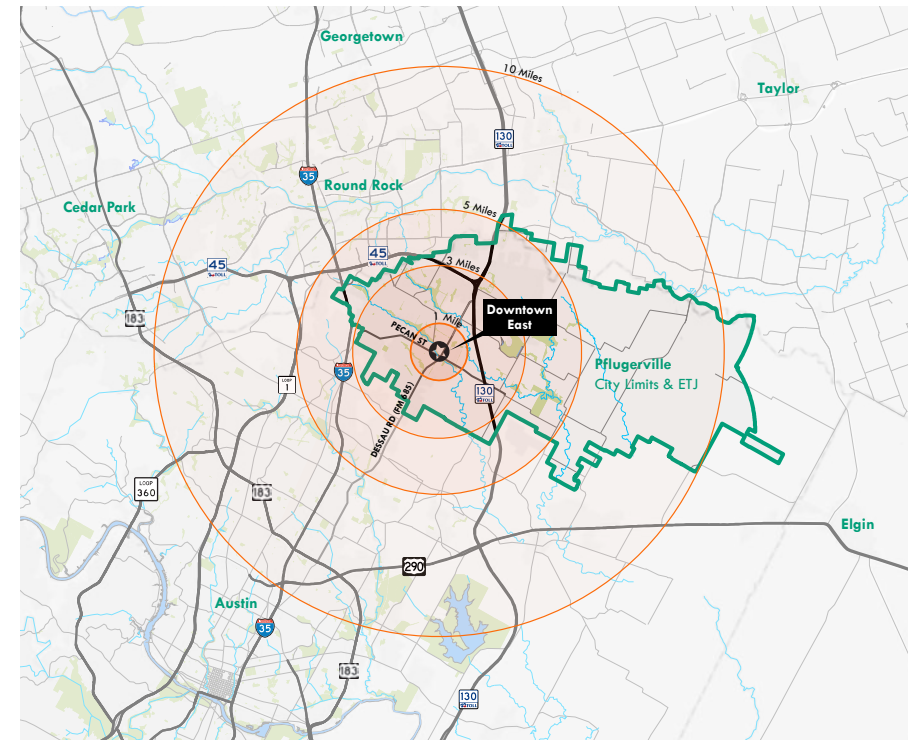


Figure 2: Vicinity Map

## 1.2 THE VISION AND GUIDING PRINCIPLES

**Downtown East is envisioned as a vibrant mixed-use district extending, enhancing and enlivening the historic downtown core.** The Pflugerville City Council passed a resolution (No. 1960-22-04-12-0980) laying out 19 goals for the Downtown East project, which are summarized into eight Guiding Principles that are the foundation for the design standards:

- Create a vibrant, sustainable, and accessible extension of Downtown that enhances Pflugerville’s *sense of history and community*.
- Create *a family-friendly mixed-use district* where people will live, work, shop, play, as well as access and engage with City government.
- Ensure continued delivery of *high-quality services in a new City Hall* that meets Pflugerville’s current and future administrative needs.
- Deliver a *multi-generational Recreation Center* to offer athletic, cultural and social enrichment to the community.
- Provide *a central gathering space* that can support civic celebrations, weekly events, as well as the day-to-day life of the community.
- Embrace emerging trends in technology and society to deliver *a district that is sustainable and resilient*.
- Promote *citywide economic development* that fosters employment, commerce, and recreation within the City limits.
- Seek *fiscally-responsible partnerships that maximize land value* and tax revenues, while reducing taxpayer burdens and City risk.



*The Downtown East District will create an enhanced pattern of open spaces that blends nature into a compact, mixed-use development.*



## 1.3 PLANNING CONTEXT

The Downtown East redevelopment project provides an important step towards realizing established policies and the community's vision for the revitalization and enhancement of the downtown. The Downtown East PUD builds upon the City of Pflugerville's related planning efforts, including:

***Aspire Pflugerville 2040 Comprehensive Plan (2022):*** The Aspire Pflugerville 2040 Comprehensive Plan establishes the vision for the City's growth over the next twenty years. The Six Guiding Principles of the Comprehensive Plan are for Pflugerville to be diverse and equitable, community oriented, fiscally responsible, environmentally sustainable, safe and healthy, and to provide economic opportunities for all. Engagement with community members revealed the desire to strengthen Pflugerville's identity as distinct from neighboring cities while maintaining a "small-town feel". The Downtown East development will establish a unique identity with a "town-scaled", mixed-use environment; creating a new activity center with a strong sense of place.



*Pflugerville's historic Main Street has a distinctive grouping of late 19th century and early 20th century mercantile buildings ...*

Aspire Pflugerville's Future Land-Use Plan designates the Downtown East site as "Mixed-Use Neighborhood" and "Parks and Open Space":

**Mixed-Use Neighborhood** development incorporates different uses such as office, retail, commercial and residential in one area. Buildings within Mixed-Use Neighborhood developments typically incorporate retail and commercial uses on the ground floor with residential or office uses on the upper floors. By mixing uses and having them in close proximity, developments are more walkable than traditional suburban commercial development. Mixed-use neighborhood developments generally incorporate amenities like plazas, public seating, and pedestrian features.

**Parks and Open Space** areas are intended to preserve open spaces for the protection and enjoyment of natural areas. Areas within this designation are primarily located along the floodway running throughout the City. Parks, trails, and other recreational amenities should be integrated into and easily accessible from residential neighborhoods and developments.



*... that contribute to the community's identity and sense of place.*

A Planned Unit Development (PUD) zoning district provides the regulatory flexibility, coordination and detail required for the Downtown East project to incorporate these future land uses on a unique site adjacent to the Historic Downtown, Gilleland Creek and residential neighborhoods. The PUD enables the City of Pflugerville to ensure the viability of the City Hall and Recreation Center projects, to promote private mixed-use neighborhood development and to preserve and enhance the parks, trails, and natural features along Gilleland Creek.

The Downtown East project helps further several of the “Aspirational Actions” described in Chapter 8 of *Aspire Pflugerville for the City’s Central District*, including: catalyzing economic development through public-private partnerships, providing new housing opportunities, promoting the development of locally-owned businesses, improving walkability and pedestrian safety, and enhancing access to and the natural beauty of Gilleland Creek and the trail system.

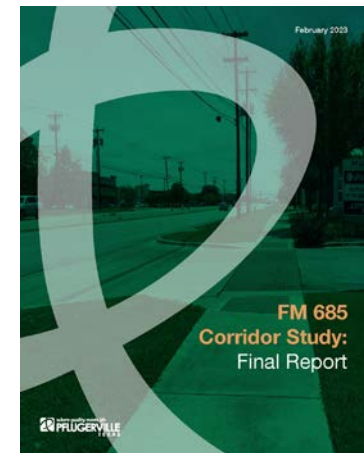
Additionally, the Downtown East project furthers many of the goals, policies and action items described in Chapter 9 of *Aspire Pflugerville* related to land use and housing, economic development and fiscal resilience, transportation and mobility, community facilities and public services, and healthy communities and neighborhood vitality.



**Downtown Action Plan (2022):** The Downtown Action Plan (DAP) lays out the City’s vision for revitalizing Downtown and lists specific goals and action items to achieve. It calls for both the proposed City Hall and Recreation Center to be located on the Pfluger Tract, allowing for the City to maintain a downtown civic presence and activity center, while offering additional opportunities for private development.

**Revision of Tax Increment Reinvestment Zone No. 1:** To support the economic viability of the Downtown East project and to fund improvements within its Historic Downtown, Pflugerville’s Tax Increment Reinvestment Zone (TIRZ) No. 1 was revised to encompass the downtown area, including the Pfluger Tract. This additional area will provide the revenue necessary to fund the infrastructure that will support Downtown East.

**FM 685 Corridor Study:** As Pflugerville continues to grow, the City’s main north-south corridor, FM 685, has become increasingly congested and unsafe. The City’s FM 685 Corridor Study recommends a multi-modal “urban boulevard” to meet the needs of bicyclists and pedestrians, as well as vehicular mobility. With this direction, the plan for Downtown East provides more specific standards for the treatment of the FM 685 frontage, in consideration of its important role as the eastern face of the Project.



## 1.4 ORGANIZATION OF THE DESIGN STANDARDS

The design standards are intended for the use of all those who are involved in the design of new improvements within Downtown East, including Griffin|Swinerton, the City of Pflugerville and supporting developers, builders, architects, landscape architects and others. The design standards are intended to supplement the development regulations of the PUD and have been developed to promote a cohesive and high-quality environment that achieves the community's vision and the guiding principles outlined above. They are intended to guide new development in ways that promote connectivity, activity, livability and sustainability. However, the design standards are not intended to be highly-prescriptive solutions that dictate a particular style or solution, but rather at allowing for creativity and innovation.



The Design Standards are organized into five subsequent chapters:

**Chapter Two: The Plan for Downtown East** outlines the key, structuring elements of the Master Plan, including a Regulating Plan that provides the basis for the development and design standards; an Illustrative Plan and Phasing Program that show how the District could develop under the provisions of the Master Plan. Potential development scenarios are described for each of the development parcels within the district.

**Chapter Three: Building Form and Development Standards** describes the general location and distribution of uses, the height and form of buildings, the relationship of ground-level uses to street frontages and open spaces and the location of parking facilities.

**Chapter Four: Building Design Standards** sets out the character and architectural treatment of buildings and parking facilities, the design of building facades, ground-level commercial and residential frontages and the treatment of parking garages and lots. It also describes acceptable building materials and signage types and their standards.

**Chapter Five: Streetscape Design Standards** describes the range of street types within Downtown East and the landscape and streetscape treatments associated with each.

**Chapter Six: Open Space Design Standards** describes the network of publicly-accessible parks and open spaces within the District, including the Civic Plaza, the buffers to the nearby single-family neighborhood and the greenbelt and trails along Gilleland Creek.



# 2

## The Plan for Downtown East

The goal of the Master Plan for Downtown East is to help guide and ultimately realize the community's vision of a vibrant, mixed-use district - one that extends and enriches the historic Downtown and achieves the Guiding Principles described in Chapter One. The Plan recognizes that full build-out of the District may take place over a decade or more, and as such, maintains a level of flexibility to respond to changing conditions and unforeseen opportunities.

## 2.1 PLAN ELEMENTS

Four principal elements provide the physical structure of the Plan for Downtown East:



### An Extended and Active Main Street

While Pflugerville’s historic Main Street will remain at the heart of this growing community, its extension eastward across Gilleland Creek into the Pfluger Tract allows for expanded retail and restaurant offerings, terminating at the new City Hall and Recreation Center. The Plan calls for the street to be designed as the pedestrian-friendly spine of the new District, with a continuous canopy of shade trees and active ground-level commercial and civic uses.



### A Mix of Public and Private Uses

In addition to participating in civic affairs at City Hall or enjoying the range of community facilities at the Recreation Center, Downtown East will also be a place to live, work and visit. Over 14 acres of real estate is set aside for a mix of multi-family residential, commercial, office and hotel uses - all with the ability to include retail and restaurant uses that can create an engaging and lively pedestrian environment.



### A Central Gathering Place

At the heart of Downtown East, the new Civic Plaza will serve as Pflugerville's community gathering place - a true "living room" of the community. Flanked by City Hall, the Recreation Center and a mix of residential and commercial uses, it is envisioned as an active 18-hour place that will enhance Pflugerville's identity and support its major celebrations, weekly markets and the everyday life of the community.



### A Riparian Greenbelt with Trails

Gilleland Creek and its Heritage Loop Trail flow through the heart of Downtown East, offering the opportunity to enhance the urban experience of the District with its natural environmental features. The Plan calls for Pflugerville's extensive network of trails - more than 40 miles - to be extended into Downtown East, along the Creek, to provide pedestrian and bicycle connections to the surrounding community, as well as a place to enjoy nature.

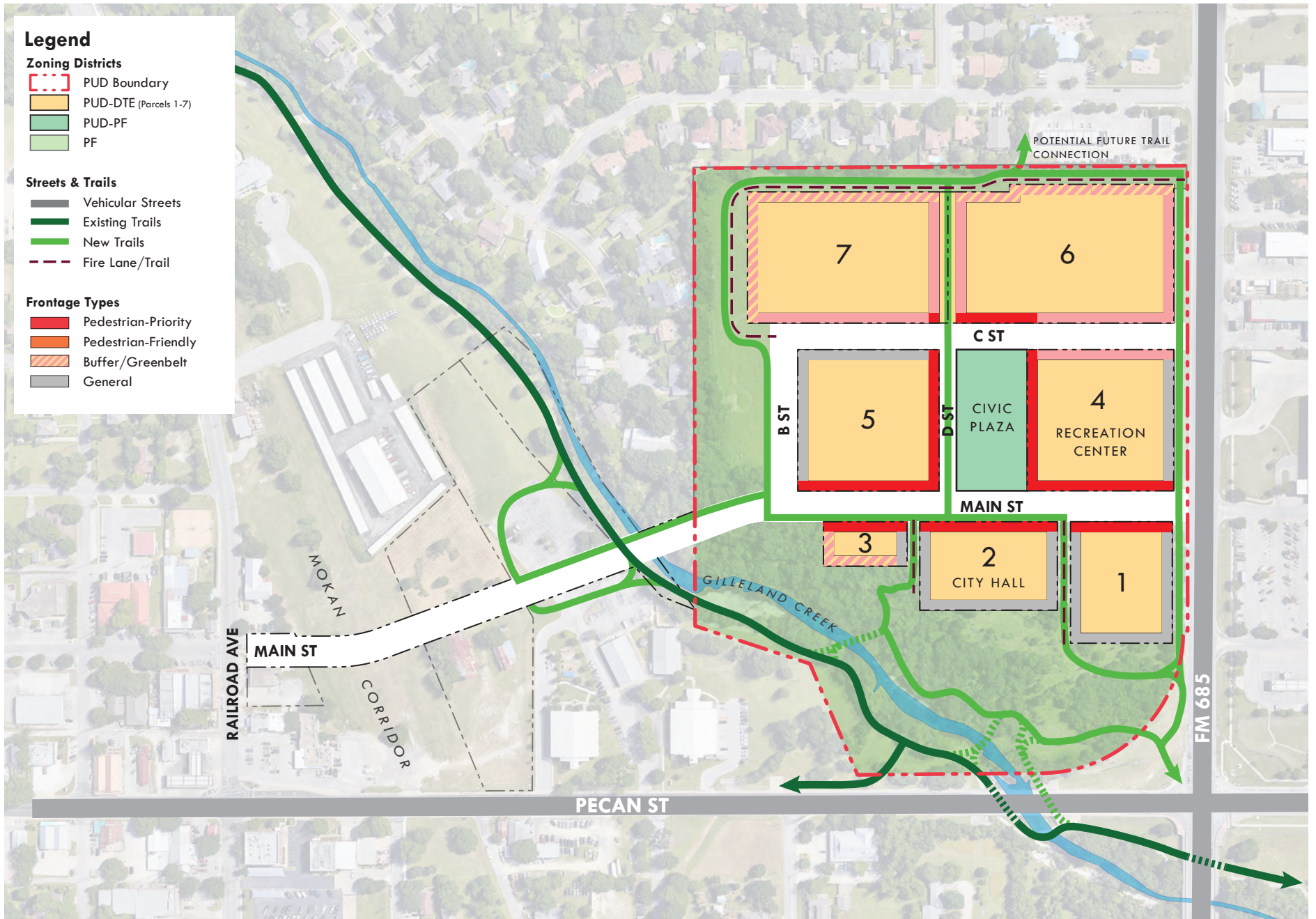


Figure 3: Downtown East Regulating Plan



## 2.2 THE REGULATING & PARCEL PLANS

Development within Downtown East will be governed by the Downtown East PUD Zoning regulations which establish allowable and conditional land uses and the general regulations related to lot area, height, building placement, coverage and impervious cover. The Downtown East Regulating Plan (Figure 3) describes in further detail the form, design and treatment of buildings and their relationship to the streets and public spaces of the District. All Downtown East development is guided by the following elements of the Regulating Plan.

**PUD Zoning Districts:** As described in Exhibit B, three zoning districts are established within the PUD boundary:

- The **PF** district includes all of the publicly accessible open space along Gilleland Creek and the greenbelt with its vegetative bufferyard between the Pfluger Tract and the single-family neighborhood to the north.
- The **PUD-PF** district includes the Civic Plaza that will include a limited amount of commercial activity intended to activate the space and to serve as the principal gathering space of Downtown East.
- The **PUD-DTE** district includes the seven development parcels within the Pfluger Tract, intended to support a mix of medium and higher-density, mixed-use development oriented to Main Street and the Civic Plaza.

Unless otherwise stated, the requirements for the PUD-DTE and PUD-PF zoning districts, set forth in this document, supersede the requirements of the Unified Development Code and the Downtown District Overlay. The requirements of the PF zoning district will comply with the requirements of the Unified Development Code and the Downtown District Overlay, unless otherwise stated.

**Street Designation Types:** A variety of street or roadway types are established for Downtown East, each with their own cross-sections, operational configurations and streetscape design. These include the internal public and private streets within the PUD boundary, the frontage of FM 685, operated by TxDOT, and fire lanes to ensure compliance with the City of Pflugerville's amendments to the International Fire Code (IFC). The street types address vehicular lane widths, number of lanes, pedestrian accommodation, street tree and landscape locations and on-street parking, as applicable. The treatment of these is described and illustrated in Chapter Five of the Design Standards.

**Open Space and Trails:** The Regulating Plan describes the planned pattern of publicly-accessible parkland, open spaces and the system of pedestrian ways and trails. These include the Civic Plaza at the heart of the District and the Greenbelt and neighborhood buffer area along Gilleland Creek and the northern and western edges of the Pfluger Tract. The Regulating Plan also illustrates the desired alignment of new trails that will connect with the Heritage Loop Trail and Pflugerville's extensive trail system beyond. Chapter Six of the Design Standards describes the design approach for these key open spaces and trails.

**The Parcel Plan:** The Regulating Plan depicts the seven development parcels within the Pfluger Tract (Parcels 1 through 7) designated as PUD-DTE. These seven development parcels provide a net developable area of approximately fifteen acres.

## 2.3 ILLUSTRATIVE MASTER PLAN & SCENARIOS

The Downtown East Planned Unit Development Zone (PUD) is flexible and allows for a variety of uses. The Illustrative Plan (Figure 5) illustrates one possible way that Downtown East could potentially build out in conformance with the Regulating Plan and these Design Standards over the next decade. It is anticipated that the site will develop in multiple phases, the first of which includes the extension of Main Street, the construction of City Hall, the Recreation Center and the Civic Plaza (Figure 4). Up to 600 surface and on-street parking spaces will be constructed during this first phase to serve

the City Hall, Recreation Center and the retail and restaurant development that is planned as part of these two facilities. An early phase could also see Parcel 5 developed for a retail and entertainment attraction with additional surface parking to help to establish Downtown East as an active, citywide and regional destination. The subsequent phases would include the remaining, privately-developed parcels for mixed-use commercial and residential development and the provision of district parking in one or more parking structures.



Figure 4: Phase 1 Illustrative Plan

The Illustrative Plan is based upon an understanding of current market conditions and will change as opportunities and new conditions present themselves. For instance, some of the sites currently illustrated as multi-family residential development could be developed for office or hotel use, should such an opportunity arise. Alternatively, sites illustrated for office or hotel use may become more suitable for residential use. Two of the

development parcels (Parcels 1 and 5) must include a component of district parking to replace and augment the surface parking that is anticipated to be developed with more intensive uses in subsequent phases.



Figure 5: Full Build-Out Illustrative Plan

## District Parking and Joint Development

Downtown East has an opportunity to benefit from shared parking with the varying and overlapping peak demand among the various land uses. For instance, peak demand for City Hall will be greatest during weekday business hours, while parking demand for the Recreation Center and the retail and restaurant uses will peak during weekend and evening hours. As such, a District Parking approach is recommended to serve City Hall, the Recreation Center, and retail and restaurant uses. District parking could also be utilized for hotel and office parking, as well as for a cinema, should such a use be viable. The proximity of these uses, all less than a five-minute walk from each other, makes a shared parking approach ideal.

During the initial phase of development (Figure 4), a total of 533 spaces of District Parking is required to serve the City Hall, Recreation Center, Civic Plaza and the retail and restaurant uses incorporated as part of these buildings (Table 1). These spaces could be provided at grade in four locations:

- 50 on-street parking spaces along B and C Streets and Main Street east of B Street;
- 100 surface spaces on Parcel 1;
- 30 surface spaces on Parcel 3; and
- 353 surface spaces on Parcel 6.

In subsequent phases, as development intensifies and as this surface parking is displaced, structured parking will be required. Up to 450 additional spaces or 1000 District Parking spaces may be needed to satisfy the demand for the additional component of retail, restaurant, hotel and entertainment-oriented uses that could occur on the site). Appendix A (Pflugerville Civic Center Preliminary Parking Needs Analysis Summary) and Table 2 illustrate the possible range of demand for District Parking. On-street parking should also be employed as part of the District Parking program. If 1,000 spaces are needed to serve these uses, two District Parking garages will be needed to meet this overall demand, one located on Parcel 1 and a second on Parcel 5. These two parcels are best suited for shared parking, because of their location adjacent to Main Street, the City Hall, the Civic Plaza and the Recreation Center. The garages shall conform with the design standards described in Chapter 3, and their exact size will depend upon the joint use on the parcel. The garages could range in size as follows:

- Up to 560 parking spaces on Parcel 1; and
- 800 parking spaces on Parcel 5.

Land Use	Project Data		Weekday					Weekday		
			Base Ratio	Driving Adj	Non-Captive Ratio	Project Ratio	Unit For Ratio	Peak Hr Adj	Peak Mo Adj	Estimated Parking Demand
	Quantity	Unit						2 PM	October	
Retail (<400 ksf)	3,000	sf GLA	2.90	99%	87%	2.49	ksf GLA	95%	69%	5
Employee			0.70	88%	100%	0.62		100%	78%	2
Fast Casual/Fast Food	8,750	sf GLA	12.40	99%	74%	9.06	ksf GLA	90%	96%	69
Employee			2.00	88%	100%	1.76		95%	100%	15
Outdoor Amphitheater	250	seats	0.30	100%	77%	0.23	seat	1%	50%	-
Employee			0.07	88%	100%	0.06		30%	60%	3
Rec Center	128,210	sf GLA	2.00	100%	87%	1.73	ksf GLA	60%	100%	134
Employee			0.25	88%	100%	0.22		75%	100%	22
Convention Center		sf GLA	5.50	100%	100%	5.50	ksf GLA	100%	85%	-
Employee			0.50	88%	100%	0.44		100%	95%	-
Office <25 ksf	14,000	sf GFA	0.30	99%	100%	0.30	ksf GFA	95%	100%	5
Reserved		empl	0.00	93%	100%	0.00		100%	100%	-
Employee			3.50	93%	100%	3.26		95%	100%	43
Government Office	50,952	sf GFA	1.19	99%	100%	1.18	ksf GFA	95%	100%	57
Reserved	1	emp	2.70	93%	100%	2.51		100%	100%	128
								Customer/Visitor		270
								Employee		85
								CH Fleet Vehicles		50
								Reserved CH Emp 6A-5P		128
								Total		533

Table 1: Phase 1 District Parking - Projected Demand

## Development Scenarios

The following provides a description of potential development scenarios for each of the five development parcels available for private or joint development. Each of these scenarios meet the development regulations in Exhibit D of the PUD and the design standards described in Chapter 3 of this exhibit:

**Parcel 1:** Parcel 1, located at the intersection of Main Street and FM 685 provides a key gateway location within Downtown East and represents a significant economic development opportunity for a commercial or employment use. The southernmost portion of the site (approximately 80 feet) lies within the floodplain. Key criteria for the development of Parcel 1 include:

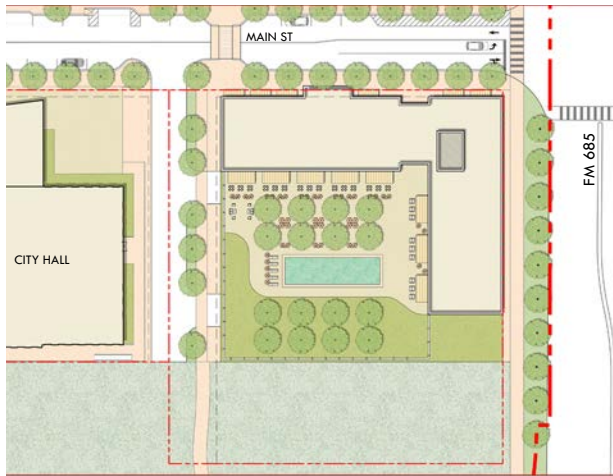
- Provision of some District Parking in a structure that does not exceed five levels or 45 feet in height;
- Some component of convenient employee and visitor parking for City Hall and Main Street retail;
- Active ground-level retail and restaurant uses oriented to Main Street;
- Upper-level uses up to 85 feet (seven levels) in height that support the life of the District, including a potential hotel or office space that could benefit from the frontage along FM 685;

Figure 6 shows three potential joint development scenarios for Parcel 1. Each of these includes a component of District Parking that would replace the 100 spaces of surface parking provided in Phase 1 (Figure 4):

- Option 1 illustrates a two-level parking podium of 160 spaces, and a 130-room five-story hotel with 6,000 square feet of ground level retail and restaurant uses along the Main Street frontage.
- Option 2 shows a five-level freestanding parking garage of 380 spaces, with an adjacent three-story commercial building containing 5,000 sf of ground-level retail and restaurant space and 60,000 square feet of office. Alternatively, this option could also support a 120-room, 5-story hotel (shown on Figure 5). The parking garage in this option would need to be constructed above the floodplain.
- Option 3 illustrates a five-level 560-car parking garage with 15,000 square feet of retail and restaurant uses along Main Street. The low intensity nature of this option is due to the larger garage that is kept largely out of the floodplain.

Parcel 1 could include more intensive development up to 85 feet in height (seven levels) if a parking program was developed to accommodate this intensity of development in the future.

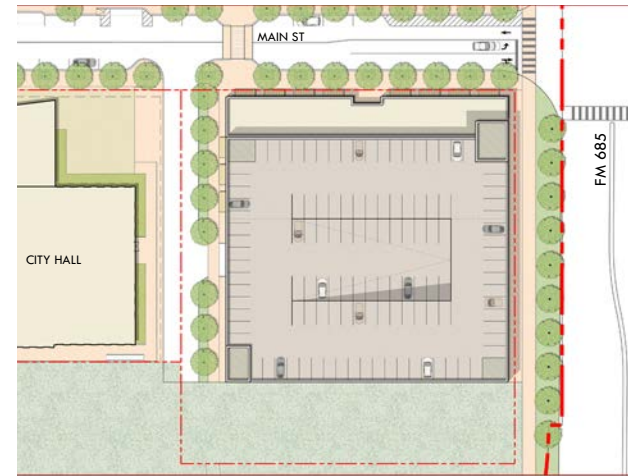
**OPTION 1:**



**OPTION 2:**



**OPTION 3:**



**Figure 6: Parcel 1 - Development Options**

**Parcel 3:** Parcel 3 is a small site of approximately 0.45 acres, located immediately west of City Hall and overlooking Gilleland Creek and the greenbelt. The developable area of the site is made even smaller since the southern portion of it is within the floodplain. Key criteria for this parcel include:

- Active ground level retail and restaurant uses along Main Street;
- Upper-level uses of two to five levels in height (35 to 65 feet) to enliven the mixed-use character of the District;
- Complementary relationship with City Hall and the greenbelt;
- Off-site parking in a District Parking facility;

Because of its small size, and the lack of on-site parking, residential is not a permitted use on Parcel 3. Figure 7 illustrates three possible development scenarios for the site, all of which would be served by parking in a District Garage on Parcel 5. These include:

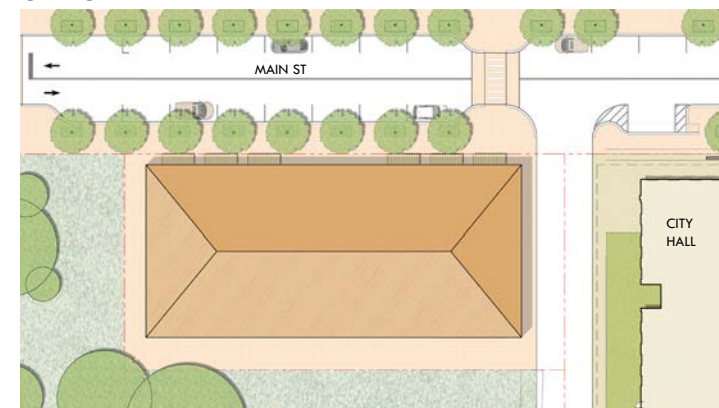
- Option 1: A cluster of one-story food and beverage uses with up to 10,000 square feet of space oriented to an outdoor garden and terraced areas.
- Option 2: A two-story 25,000 square foot mixed-use commercial building with 10,000 square feet of ground level retail and restaurant space and 15,000 square feet of office.
- Option 3: A five-story hotel with 120 rooms and 5,000 square feet of ground level retail and restaurant space.

Both Options 2 and 3 would require the building to be elevated and project over the floodplain on piers.

**OPTION 1:**



**OPTION 2:**



**OPTION 3:**



**Figure 7: Parcel 3 - Development Options**

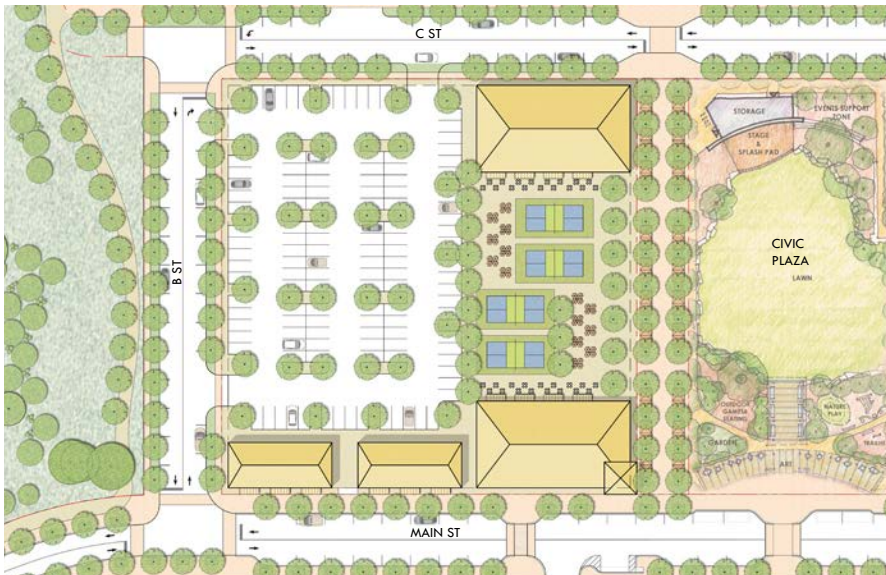
**Parcel 5:** Parcel 5 is a strategic site due to its size and its location adjacent to Main Street, City Hall, the Recreation Center and the Civic Plaza. Key criteria for its development include:

- Accommodation of an active retail and entertainment use in the early term, that can enhance the destination appeal of Downtown East and energize the Civic Plaza;
- Active ground level uses along Main Street;
- Provision of up to 800 District Parking spaces in a structure that does not exceed six levels or 65 feet in height;
- Inclusion of other upper-level uses that can enliven the District and that can visually screen and encapsulate the garage to the maximum extent possible.

The City of Pflugerville would like to attract an early-term use within the next few years to this important parcel adjacent to the Civic Plaza and across the street from City Hall. Figure 8 shows one possible scenario that envisions a one and two-story complex of retail, restaurant and entertainment uses oriented around an outdoor space that could include a beer garden, pickleball courts, or other recreational facilities. Such a facility would need to provide its own parking beyond the 533 District spaces that are planned for Phase 1. This concept illustrates a facility with 20,000 square feet of interior space and 130 surface parking spaces. The facility would need to be constructed in a way that would not impede future development of a District Garage on the site. It could also be conceived as a temporary facility intended for redevelopment in the future, featuring food trucks, reused shipping containers and/or other temporary structures.

Beyond this initial phase of construction, Figure 9 illustrates three potential joint development scenarios for Parcel 5, each of which include a District Garage.

**EARLY-TERM DEVELOPMENT OPTION:**



**Figure 8: Parcel 5 - Early-Term Development Option**

**OPTION 1:**



**Figure 9: Parcel 5 - Development Options**



- Option 1 shows a parking garage of 800 spaces on six levels. This three-bay sloped-floor garage is set back by at least 50 feet from Main Street and 130 feet from the D Street Promenade to accommodate 30,000 square feet of retail and restaurant uses on two floors. This option allows for the early term retail/entertainment uses described above (Figure 8) to remain, with the District Garage replacing the surface parking lot of that use.
- Option 2 assumes full redevelopment of the site with a four-level 630-car garage with ground level retail and restaurant space along Main Street and a two-story mixed-use cinema building with ground level food and beverage uses oriented to the Civic Plaza.
- Option 3 illustrates the potential for a mixed-use residential building with 220 apartments and 30,000 square feet of ground level retail, food and beverage uses, encapsulating a six-level shared garage with 415 District spaces and 220 dedicated residential spaces.

Each of these options complies with the development regulations set forth in Exhibit D of the PUD and with the design standards described in Chapter 3.

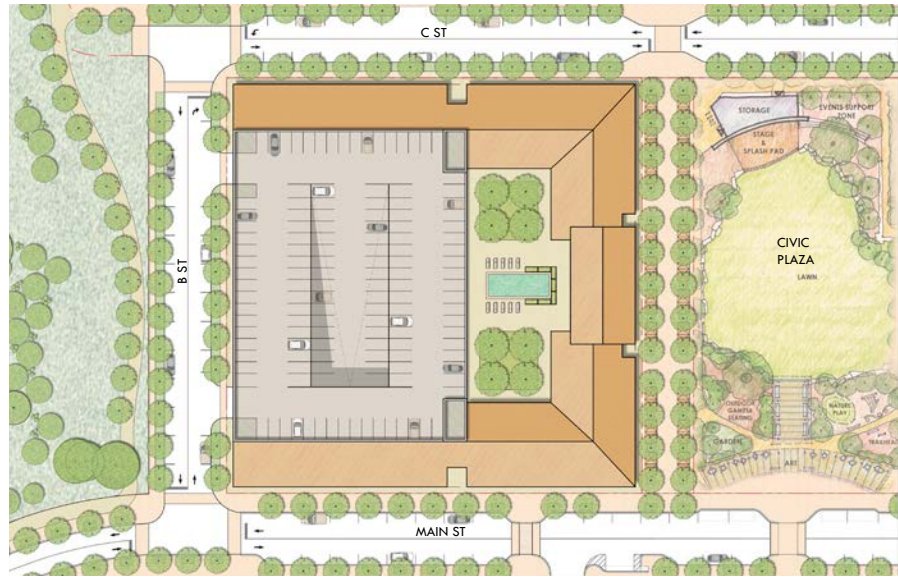


The City would like to attract an early-term use that can help to activate the Civic Plaza and reinforce Downtown East as an attractive destination.

**OPTION 2:**



**OPTION 3:**



**Parcels 6 & 7:** The two parcels along the northern edge of the Pfluger Tract are well suited for multi-family residential and mixed-use development, securing Downtown East as an attractive place to live with neighborhood amenities that are immediately adjacent. In the near term, Parcel 6 will be set aside for interim surface parking to serve the needs of the Recreation Center and the Civic Plaza. As such, its full development will need to await the completion of one or two of the district parking garages described above. Parcel 7, however, could be marketed for residential development at any point. Key criteria for Parcels 6 and 7 include:

- Compatibility in scale and activity with the single-family neighborhoods to the north, with a step-back in height, as described in Chapter 3.6 and a vegetated buffer yard as described in Chapter 6.3;
- On-site parking, screened or encapsulated from predominant public view;
- Densities of at least 40 du/ac to maximize the resident population of Downtown East;
- Inclusion of a limited amount of ground level commercial use oriented to the Civic Plaza;
- Potential for an office component along the FM 685 frontage.
- High quality on-site resident-serving amenities;

Three development scenarios are illustrated for Parcels 6 and 7 (Figure 10):

**Option 1: Garden Urban Apartments:** Market studies for the property indicate that structured parking within multi-family residential development is not financially feasible at this point in time. If there is demand for an early-term residential project, it is possible to achieve an urban building prototype with surface parking that could meet the requirements of the Regulating Plan and the design standards. With this prototype, nicknamed Garden Urban or “Gurban”, the surface parking is encapsulated within the parcel, surrounded by two to three levels of apartments (see Figure 10). This could result in 140 units on Parcel 6 and an additional 134 units on Parcel 7, with some ground-level amenities and commercial space oriented to the Civic Plaza.

**Option 2: Urban Residential Apartments:** As structured parking becomes viable, Parcels 6 and 7 would be highly suitable for a higher-density, three to five-level multi-family apartment complex with encapsulated parking garages on each of the blocks. In this scenario, development of both blocks could yield a total of up to 665 units to achieve a density approaching 100 du/ac with 5,000 square feet of ground-level commercial use or resident-serving amenities.

**Option 3: Mixed-Use Residential and Office:** A variation of Option 2 could introduce a three-story office building on Parcel 6 oriented to FM 685. This office building of approximately 100,000 square feet would share a garage with the multi-family apartment on the western half of the parcel, yielding 200 residential units on that half of the block or an overall total of 515 units on Parcels 6 and 7. The parking garage for this mixed-use development could also be shared during off-peak periods (i.e., evenings and weekends) with the Recreation Center immediately to the south.

Regardless of which scenario may ultimately occur on these parcels, the standards set forth in the subsequent chapters of this exhibit shall prevail.



*Parcels 6 and 7 are well-suited for multifamily residential and mixed-use development.*

**OPTION 1:**



**OPTION 2:**



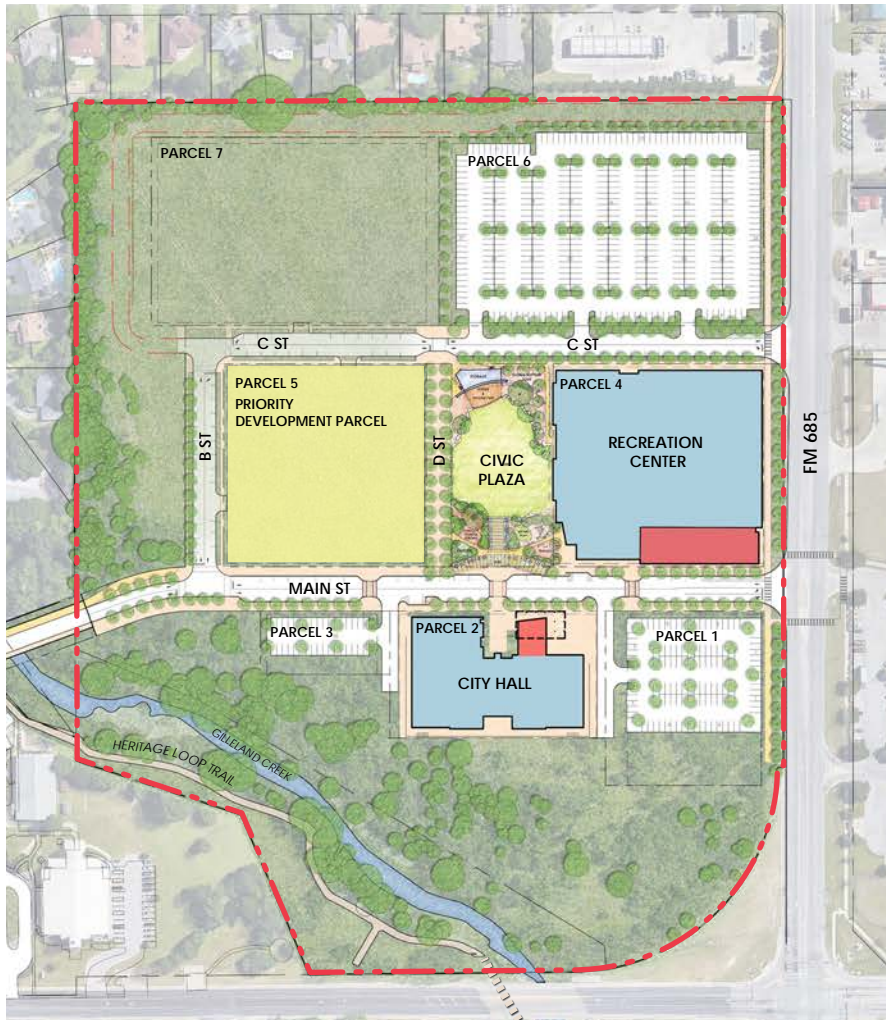
**OPTION 3:**



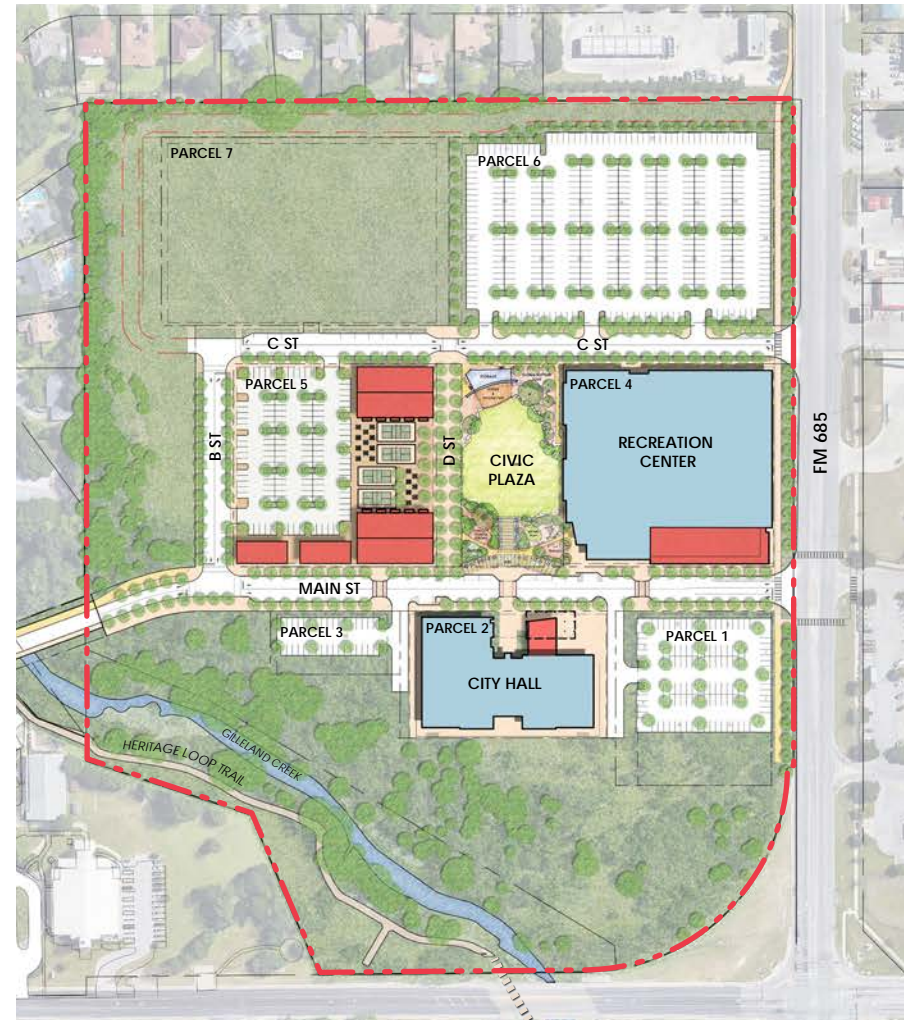
**Figure 10: Parcels 6 & 7 - Development Options**

## Illustrative Phasing Plan

Figure 11 shows how the Illustrative Plan could be phased over a 15-year time frame. This is just one example of how the project could evolve, utilizing some of the parcel concepts described above. Market conditions or developer preferences may result in different scenarios. However, phasing will need to ensure that adequate parking is provided for City Hall, the Recreation Center and retail at each stage of development.

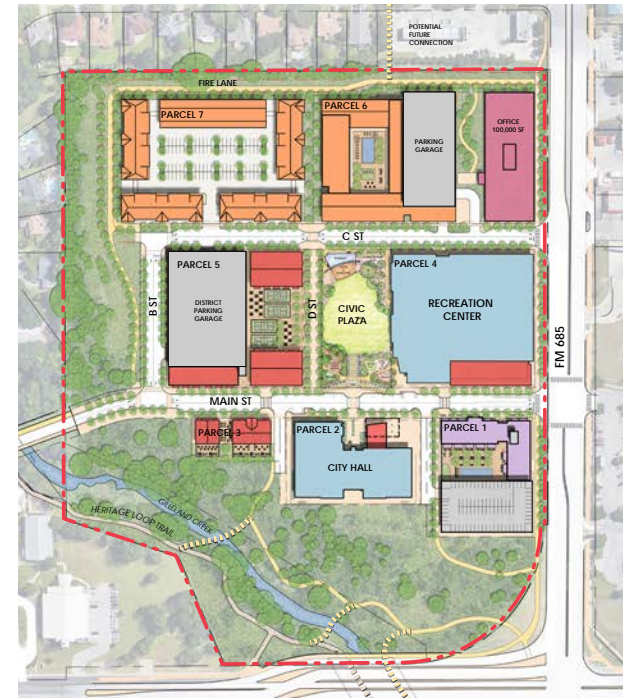


**Phase 1** depicts the City Hall, Recreation Center and the retail and restaurant space within those two facilities. 483 parking spaces are shown in three surface parking lots on Parcels 1, 3 and 6 and an additional 50 parallel spaces are provided along the streets;



**Phase 1A** introduces an early-term commercial and entertainment facility of 30,000 square feet on Parcel 5, along with 130 surface parking spaces to support it.

**Figure 11: Illustrative Phasing Concept**



**Phase 2A** shows new private development coming online including 134 units of multifamily “garden urban” residential on Parcel 7 and illustrates the Districts’ transition to structured parking as follows:

- The phased redevelopment of the surface parking lot on Parcel 1 begins with a five-level freestanding parking garage of 380 spaces on the southern edge of the site, preserving surface parking along Main Street during its construction (left diagram). Then, the remaining surface parking on Parcel 1 could be redeveloped into a commercial building containing 5,000 sf of ground-level retail/restaurant space and up to 60,000 square feet of mixed-use commercial (e.g., office, hotel)
- Prior to redevelopment of Parcels 3 and 6, the surface parking lot on Parcel 5 would redevelop as a 580-car District Garage.

**Phase 2B** could see the completion of the development, with 200 residential units and a 100,000 square foot office building on Parcel 6, and 30,000 square feet of additional commercial-recreational uses on Parcel 3.

PFLUGERVILLE DOWNTOWN EAST  
 POTENTIAL BUILD-OUT DEVELOPMENT PROGRAMS  
 May 20, 2024

OPTION ONE		USES TO BE DISTRICT PARKED									USES TO BE PARKED ON-SITE					PARKING PROVIDED	
Parcel	acres	CITY HALL gsf	REC CTR gsf	RETAIL/F+B gsf	HOTEL keys	OFFICE gsf	CINEMA seats	MULTI-FAM du	DISTRICT PARKING spaces	MULTI-FAMILY du	RETAIL/F+B gsf	HOTEL keys	OFFICE gsf	ON-SITE PARKING spaces	spaces	description	
1	1.55	0	0	6,000	130	0	0	0	80	0	0	0	0	0	160	2-level podium or other	
2	1.56	89,750	0	1,250	0	14,000	0	0	Incl in Parcel 4	0	0	0	0	0	0	0	
3	0.47	0	0	10,000	0	0	0	0	97	0	0	0	0	0	0	0	
4	3.61	0	128,210	10,500	0	0	0	0	617	0	0	0	0	0	0	0	
5	2.35	0	0	30,000	0	0	0	0	195	0	0	0	0	0	800	6-level garage	
6	3.64	0	0	0	0	0	0	0	0	140	0	0	0	172	172	surface "gurban"	
7	3.1	0	0	0	0	0	0	0	0	134	0	0	0	164	164	surface "gurban"	
TOTAL	16.28	89,750	128,210	57,750	130	14,000	0	0	989	274	0	0	0	336	1,296		

OPTION TWO		USES TO BE DISTRICT PARKED									USES TO BE PARKED ON-SITE					PARKING PROVIDED	
Parcel	acres	CITY HALL gsf	REC CTR gsf	RETAIL/F+B gsf	HOTEL keys	OFFICE gsf	CINEMA seats	MULTI-FAM du	DISTRICT PARKING spaces	MULTI-FAMILY du	RETAIL/F+B gsf	HOTEL keys	OFFICE gsf	ON-SITE PARKING spaces	spaces	description	
1	1.55	0	0	5,000	0	60,000	0	0	206	0	0	0	0	0	380	5-level garage	
2	1.56	89,750	0	1,250	0	14,000	0	0	Incl in Parcel 4	0	0	0	0	0	0	0	
3	0.47	0	0	5,000	0	20,000	0	0	110	0	0	0	0	0	0	0	
4	3.61	0	128,210	10,500	0	0	0	0	641	0	0	0	0	0	0	0	
5	2.35	0	0	20,000	0	0	600	0	121	0	0	0	0	0	800	6-level garage	
6	3.64	0	0	0	0	0	0	0	0	350	0	0	0	425	528	6-level garage	
7	3.1	0	0	0	0	0	0	0	0	315	0	0	0	382	164	surpace "gurban"	
TOTAL	16.28	89,750	128,210	41,750	0	94,000	600	0	1,078	665	0	0	0	807	1,872		

OPTION THREE		USES TO BE DISTRICT PARKED									USES TO BE PARKED ON-SITE					PARKING PROVIDED	
Parcel	acres	CITY HALL gsf	REC CTR gsf	RETAIL/F+B gsf	HOTEL keys	OFFICE gsf	CINEMA seats	MULTI-FAM du	DISTRICT PARKING spaces	MULTI-FAMILY du	RETAIL/F+B gsf	HOTEL keys	OFFICE gsf	ON-SITE PARKING spaces	spaces	description	
1	1.55	0	0	15,000	0	0	0	0	59	0	0	0	0	0	560	5-level garage	
2	1.56	89,750	0	1,250	0	14,000	0	0	Incl in Parcel 4	0	0	0	0	0	0	0	
3	0.47	0	0	5,000	120	0	0	0	67	0	0	0	0	0	0	0	
4	3.61	0	128,210	10,500	0	0	0	0	630	0	0	0	0	0	0	0	
5	2.35	0	0	20,000	0	0	0	220	346	0	0	0	0	0	610	6-level garage	
6	3.64	0	0	0	0	0	0	0	0	200	0	0	100,000	528	528	6-level garage	
7	3.1	0	0	0	0	0	0	0	0	315	0	0	0	382	470	6-level garage	
TOTAL	16.28	89,750	128,210	51,750	120	14,000	0	220	1,102	515	0	0	100,000	910	2,168		

ILLUSTRATIVE PLAN

ILLUSTRATIVE PLAN		USES TO BE DISTRICT PARKED									USES TO BE PARKED ON-SITE					PARKING PROVIDED	
Parcel	acres	CITY HALL gsf	REC CTR gsf	RETAIL/F+B gsf	HOTEL keys	OFFICE gsf	CINEMA gsf	MULTI-FAM du	DISTRICT PARKING spaces	MULTI-FAM du	RETAIL/F+B gsf	HOTEL keys	OFFICE gsf	ON-SITE PARKING spaces	spaces	description	
1	1.55	0	0	6,000	130	0	0	0	80	0	0	0	0	0	160	2-level podium or other	
2	1.56	89,750	0	1,250	0	14,000	0	0	Incl in Parcel 4	0	0	0	0	0	0	0	
3	0.47	0	0	10,000	0	0	0	0	97	0	0	0	0	0	0	0	
4	3.61	0	128,210	10,500	0	0	0	0	617	0	0	0	0	0	0	0	
5	2.35	0	0	30,000	0	0	0	0	195	0	0	0	0	0	800	6-level garage	
6	3.64	0	0	0	0	0	0	0	6	200	0	0	100,000	522	528	6-level garage	
7	3.1	0	0	0	0	0	0	0	3	134	0	0	0	160	164	surface "gurban"	
TOTAL	16.28	89,750	128,210	57,750	130	14,000	0	0	998	334	0	0	100,000	682	1,652		

Source: Walker Consultants

Table 2: Development Program Options and Parking Demand

# 3

## Building Form and Development Standards

Development standards in this chapter deal with the basic form and placement of buildings including: the location of certain uses, building height and setbacks, setbacks and build-to lines, the relationship of ground level uses to street and plaza frontages and the location and treatment of parking facilities. These standards apply to buildings within the development parcels designated as PUD-DTE and those in the Civic Plaza designated as PUD-PF.

## 3.1 LOCATION OF USES

Although a diverse mix of uses - within the list of prescribed uses described in Exhibit C of this PUD - is encouraged throughout the District, there are some limitations on the location of certain uses, as described below.

1. Residential development is not permitted in the Civic Plaza or on the following three parcels:
  - Parcel 2, the location for the Pflugerville City Hall;
  - Parcel 3, because of its limited size and inability to accommodate on-site parking; and
  - Parcel 4, the location for the planned Recreation Center.
2. Residential development is an auxiliary use on Parcels 1 and 5 to the primary use which includes commercial, retail and restaurant and District Parking.
3. Along frontages designated as “Pedestrian-Priority” the following ground level street front uses are not permitted within 30 feet of the property line of those frontages:
  - residential dwelling units
  - general office
  - automotive parking lot/garage
4. If “Pedestrian-Priority” frontages are designed to be “retail-ready” as described in Section 4.6, residential and office uses may be permitted, subject to Planning Director approval.



*Above is an example of a mixed use building with ground-level commercial uses, that could be developed on Parcels 1, 3, 5, 6 and 7.*



## 3.2 BUILDING HEIGHT & MASSING

The following standards are related to the minimum and maximum height of buildings within the Downtown East District:

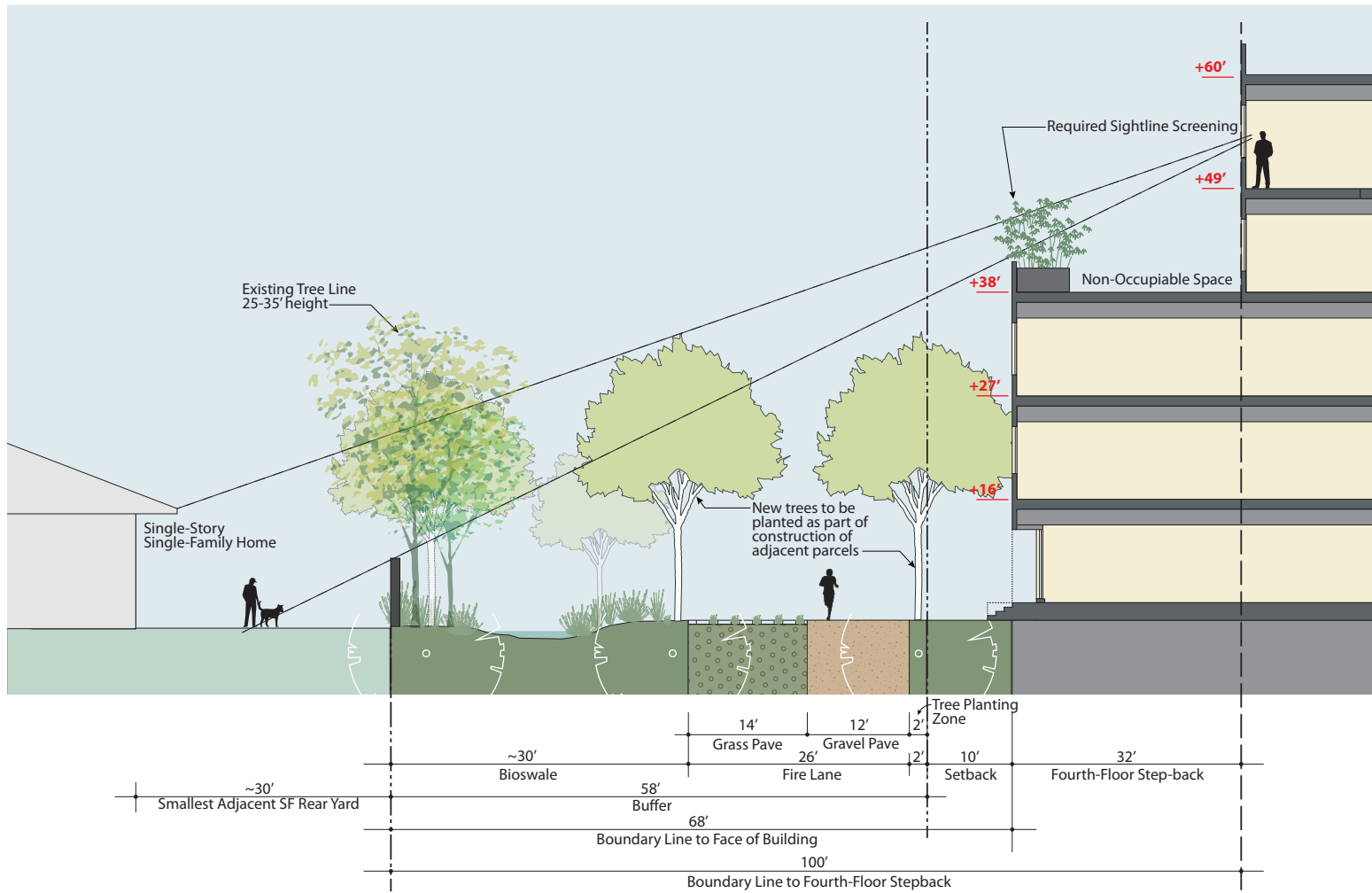
1. **Properties designated as PUD-DTE** shall not exceed 65 feet in height or six floors, with the following exceptions:
  - a. Development on Parcels 6 and 7 within 100 feet of a property with a single-family zoning district designation shall not exceed three floors or 40 feet in height (see Figures 13A and 13B).
  - b. Development on Parcels 1 and 6 within 170 feet of the FM 685 frontage shall not exceed a height of seven floors or 85 feet.
  - c. A parking structure on Parcel 1 may not exceed five levels or 45 feet in height.
  - d. A parking structure on Parcel 6 may not exceed seven levels or 65 feet in height.
2. **The Minimum Height of Development** on properties designated as PUD-DTE shall be two floors or 30 feet in height. An exception to this minimum height may be approved by the Planning Director if the development supports the goal of activating the pedestrian environment. No such exception shall be granted for residential or office developments.
3. **The Ground-Floor Height of Non-Residential Spaces** along a “Pedestrian- Priority” frontage within the PUD-DTE district shall have a minimum floor-to-floor height of 16 feet. The finished elevation of usable ground-floor space shall be generally flush with the sidewalk and no more than 12 inches above it. The Planning Director may approve an exception to these requirements if it is deemed that site conditions preclude compliance, and that every effort has been made to maximize the relationship and flow between indoor and outdoor activities (see Figure 14).
4. **Residential ground-floor units** shall be elevated by at least 18 inches above the level of the sidewalk, but by no more than 60 inches (see Figure 14).
5. **Buildings within the Civic Plaza (PUD-PF)** shall not exceed 25 feet or one-story in height.



### Legend

- PUD Boundary
- Max. height 40 ft (or 3 floors)
- Max. height 65 ft (or 5 floors)
- Max. height 85 ft (or 7 floors)

Figure 12: Height Diagram



**Figure 13A: Height/Step-back in Relation to Single-Family Homes along Cedar Ridge Drive**

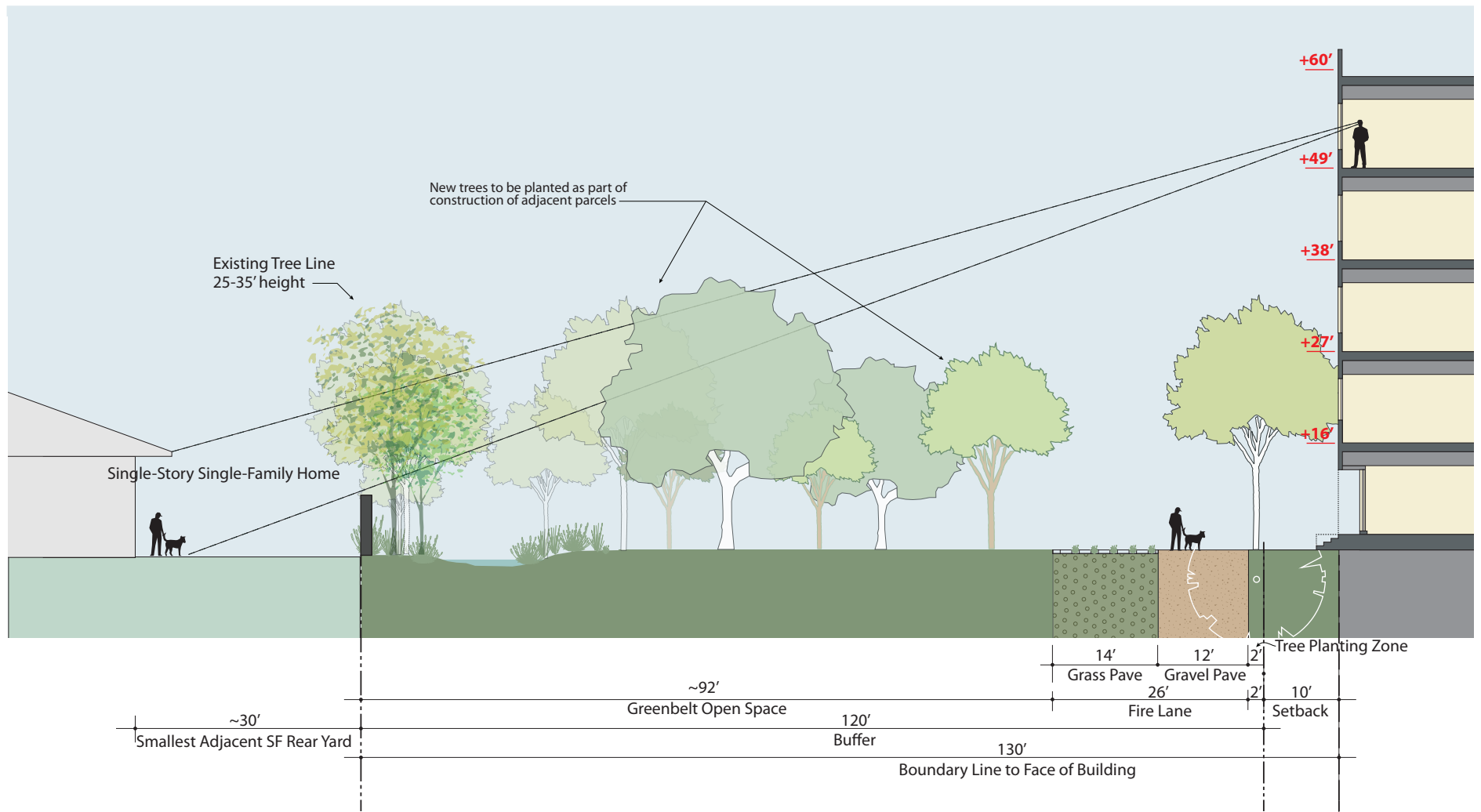
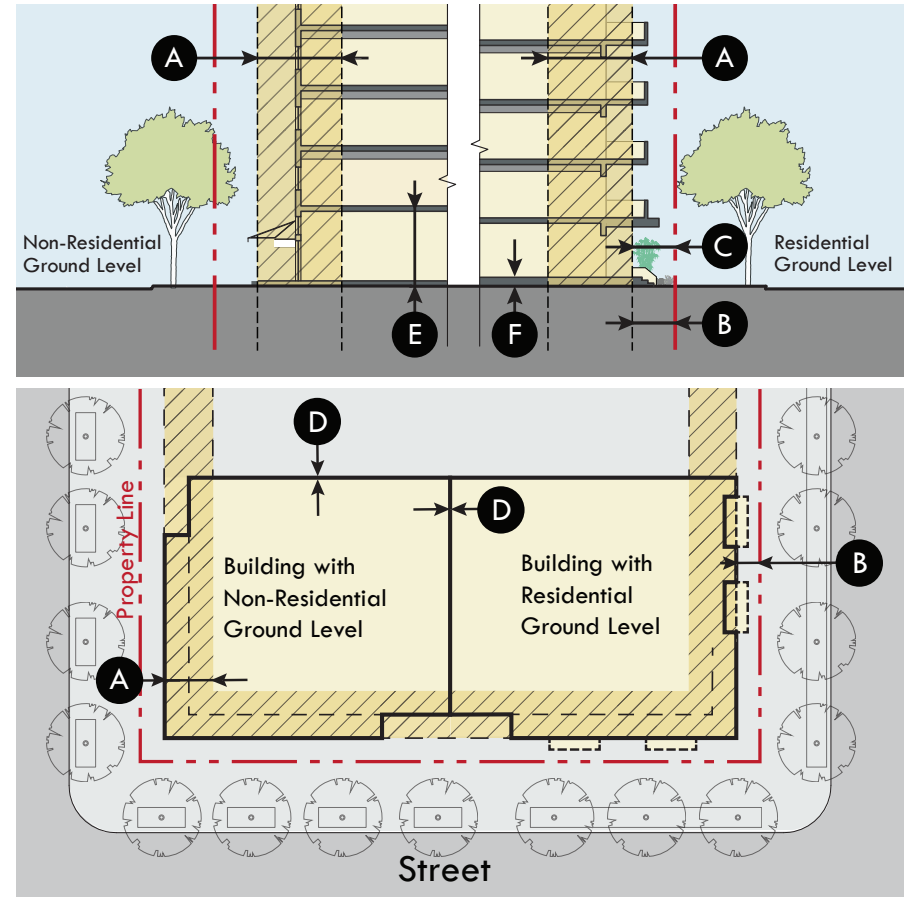


Figure 13B: Height/Step-back in Relation to Single-Family Homes along Meadow Creek Drive

### 3.3 BUILDING PLACEMENT

This standard describes the relationship of new buildings to the public realm of Downtown East with the goal of ensuring that buildings help to activate and define the streets, plaza and other public spaces of the district, making them comfortable, safe and interesting places for pedestrians to move through and enjoy. More specifically:

- 1. Build-to Zone:** All development on designated “Pedestrian-Priority” and “Pedestrian-Friendly” frontages shall be built to between five (5) and fifteen (15) feet of the right-of-way line along the street front of the parcel. Along these frontages, the Planning Director may extend the build-to line to accommodate cafe seating or plaza extensions. On frontages designated as “Neighborhood Buffer/Greenbelt” or “General”, no build-to line is imposed.
- 2. Buildings with ground level residential uses** must be set back from the street front right-of-way line by a minimum of five (5) feet. Covered porches and entry stoops are permitted to encroach within the setback area by up to three (3) feet, provided that at least 50% of the setback area includes landscaping.
- 3. Buildings on the northern edge of Parcels 6 and 7** shall be set back by at least 10 feet from the greenbelt and bufferyard adjacent to the single-family homes.
- 4. Buildings within the Civic Plaza** shall comply with the setback requirements of the PUD set forth in Exhibit D Development Regulations.



- A** Build-to Zone (BTZ) = 5 feet to 15 feet maximum from the streetfront property line of all street frontages designated as “Pedestrian Priority” or “Pedestrian Friendly”.
- B** Ground Level Residential Setback Area = 5 feet from streetfront property line.
- C** Covered stoops and porches may project into the setback area up to 3 feet, provided that 50% of the setback area is landscaped.
- D** Rear / Side yards are 0 feet.
- E** Non-Residential Ground Floor-to-Floor Height = Minimum 16 feet
- F** Residential Unit Finished Floor Elevation = Minimum 18 inches/ Maximum 60 inches above the sidewalk.

Figure 14: Building Placement

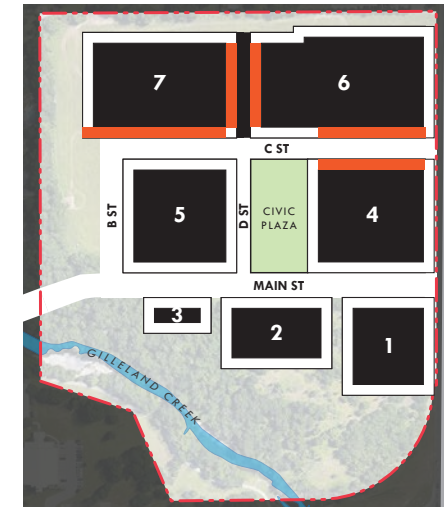
### 3.4 PEDESTRIAN-PRIORITY FRONTAGE REQUIREMENTS

Along Pedestrian-Priority street frontages, the following requirements pertain to the placement of new construction:

1. At least 80% of building fronts shall be constructed within the Build-to Zone along the street.
2. Ground floors shall be built to Commercial/“Retail-Ready” standards as described in Chapter Four.
3. Live-work units, where the work space is on the ground floor and the living space is above, are permitted on these frontages.
4. Building entries shall be constructed at frequent intervals (no greater than 50 feet) along the frontage to maximize activity along the street and open space frontages.
5. Shading with projecting awnings or canopies shall be provided along at least 50% of new building frontages.



Pedestrian-Priority Frontages

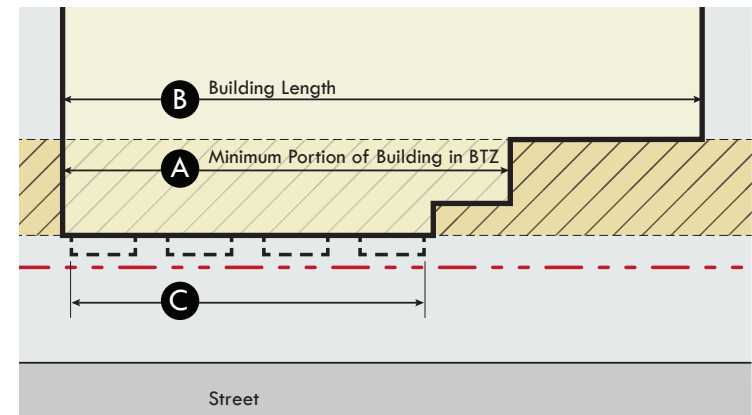


Pedestrian-Friendly Frontages

### 3.5 PEDESTRIAN-FRIENDLY FRONTAGE REQUIREMENTS

Along street frontages designated as Pedestrian-Friendly, the following requirements shall be followed:

1. At least 70% of the building fronts shall be constructed within the Build-to Zone along the street.
2. Ground floors shall be built to “Retail-Ready” standards, as described in Chapter Four, or with ground-level residential, live-work or hotel units.
3. Ground-floor residential units shall have their primary entries from stoops or porches, with direct access from the sidewalk and must comply with the standard for ground-level residential space in Chapter Four.



#### LEGEND

- Building Area
- Build-to Zone (BTZ)
- A / B Min. 80% - “Pedestrian-Priority” Street Frontage  
Min. 70% - “Pedestrian-Friendly” Street Frontage
- C Projecting awnings or canopies shall be provided along at least 50% of “Pedestrian-Priority” Street Frontage

Figure 15: Building Frontage Requirements

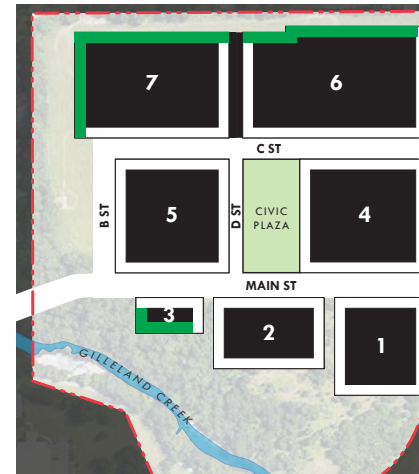
## 3.6 NEIGHBORHOOD BUFFER / GREENBELT FRONTAGE REQUIREMENTS

Along frontages designated as Neighborhood Buffer/Greenbelt, the Planning Director shall determine that every reasonable effort has been made to maximize the relationship between indoor and outdoor activities, and that the treatment of these frontages presents a positive edge to the adjacent context.

1. Buildings along the Gilleland Creek Greenbelt shall provide ground-level uses with outdoor terraces or open spaces that have an outlook and access to the open space and Creek.
2. Buildings with frontages along the Neighborhood Buffer Areas shall provide ground-level uses that provide visual overlook and/or access to enhance the safety and activity of these greenway spaces.
3. Balconies or upper level outdoor common areas that provide overlook to single-family properties are not permitted on Parcels 6 or 7. Multi-family buildings on these parcels shall be designed with vegetative (e.g., roof planting, trellises) or architectural screening (e.g., walls) that block direct sight lines between apartment units and the back yards of single-family dwellings (see Figure 13A). Additional ground level vegetative screening shall be provided within the open spaces as described in Chapter 6.3.

## 3.7 GENERAL FRONTAGE REQUIREMENTS

Along street frontages designated as “General”, it is recognized that service and parking uses may be required, but to the extent possible efforts should be made to create continuous street walls with ground-level uses that activate the pedestrian realm and spatially define the public right-of-way. Where active uses are not feasible, efforts should be made to introduce architectural interest with fenestration, public art, murals, specialty lighting, and landscaping.



*Neighborhood Buffer/Greenbelt Frontages*



*General Frontages*

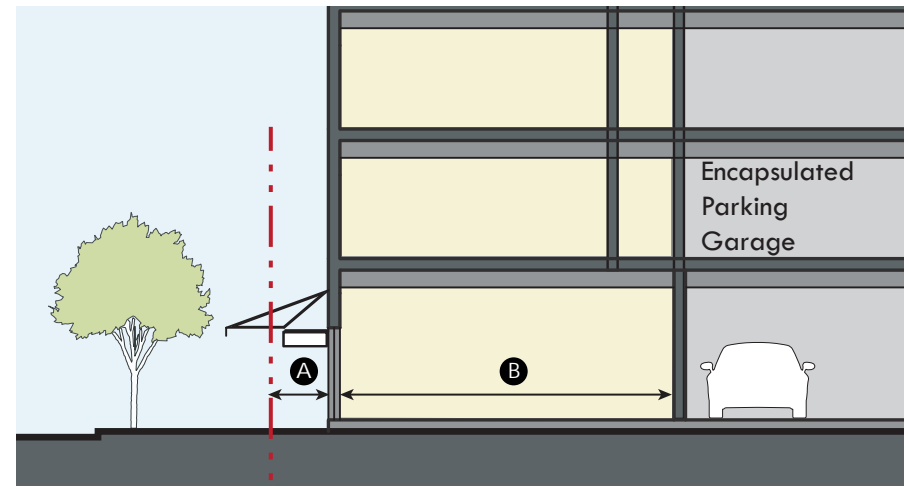


*Ground-level uses with raised porches and terraces enhance the safety and activity of the adjacent greenspace. Balconies must be designed to prevent any visual overlook to adjacent single-family homes*

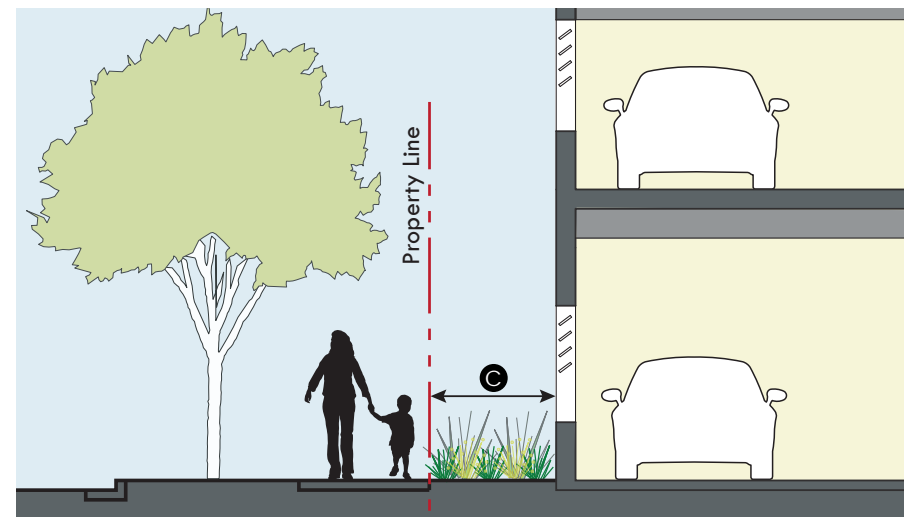
### 3.8 PARKING GARAGES

District parking garages and parking within mixed-use, multi-family and commercial buildings shall be located and treated as follows:

1. Parking garages shall be predominantly encapsulated within, behind or below buildings in a manner that conceals the facilities from public view and that do not interrupt the continuity of the pedestrian environment. All above-grade parking structures must be designed to be consistent with and/or complementary to the architectural treatment of the principal building on the parcel.
2. Along frontages designated as Pedestrian-Priority and Pedestrian-Friendly, the ground level of parking garages shall be set back at least 35 feet from the right-of-way line along the street and encapsulated within the principal building, to allow for ground-level uses (e.g., retail or “retail-ready” uses along Pedestrian Priority frontages and residential or hotel units along Pedestrian Friendly frontages). The parking facility shall not be visible from these ground-level street or open space frontages (Figure 16).
3. While exposed or stand-alone parking garages are discouraged throughout Downtown East, the Planning Director may permit them if:
  - a. The garage provides public and shared parking for the District;
  - b. The ground level portion of the garage is not exposed to a Pedestrian-Priority or Pedestrian-Friendly frontage.
  - c. Any exposed portion of a garage, visible from a public street or open space is architecturally-treated with high-quality materials and elements.
  - d. Any exposed portion of a garage that is permitted on the ground level must include a landscaped buffer of at least five feet in width, if adjacent to a public sidewalk or trail. (Figure 16)
4. Garage requirements for multifamily development as described in Subchapter 9 of the UDC are not applicable. Surface parking for multifamily is permitted, provided that such parking is encapsulated within the parcel and screened from predominant view.



Garages on “Pedestrian-Priority” or “Pedestrian-Friendly” frontage



Garages on General frontage

- A** Minimum 5-foot setback on “Pedestrian-Priority/ Pedestrian-Friendly” Street frontage.
- B** Minimum Depth of Retail Space = 30 feet.
- C** Minimum 5-foot landscape setback on General Frontages.

Figure 16: Parking Garages

### 3.9 SURFACE PARKING LOTS

Surface parking lots shall be permitted within Downtown East, subject to the following:

1. Surface lots with more than 50 spaces shall be designed as interim facilities to allow for more intensive, mixed-use development in the future.
2. Subject to the approval of the Planning and Development Services Director interim parking lots may be designed with alternate materials that provide environmental benefits and increased permeability. This may include the use of permeable pavers, comprised of a combination of interlocking grids laid over a prepared subsurface, such as gravel or crushed limestone. Such parking lots shall be required to be graded

and drained to dispose of surface water accumulated within the area. Drainage may be directed via under-drains to storm sewers and/or to bioswales. Individual parking spaces should be delineated with wheel stops. Where daily use of the parking lot is expected, or where vehicle loads require, drive aisles shall be constructed with asphalt or concrete. Figure 17 illustrates one possible design approach for an interim parking lot.

3. Surface parking facilities located along a Pedestrian Priority or Pedestrian-Friendly Street shall include a 10-foot landscaped zone with low planting that provides visual screening and shade trees at intervals of no more than 30 feet.

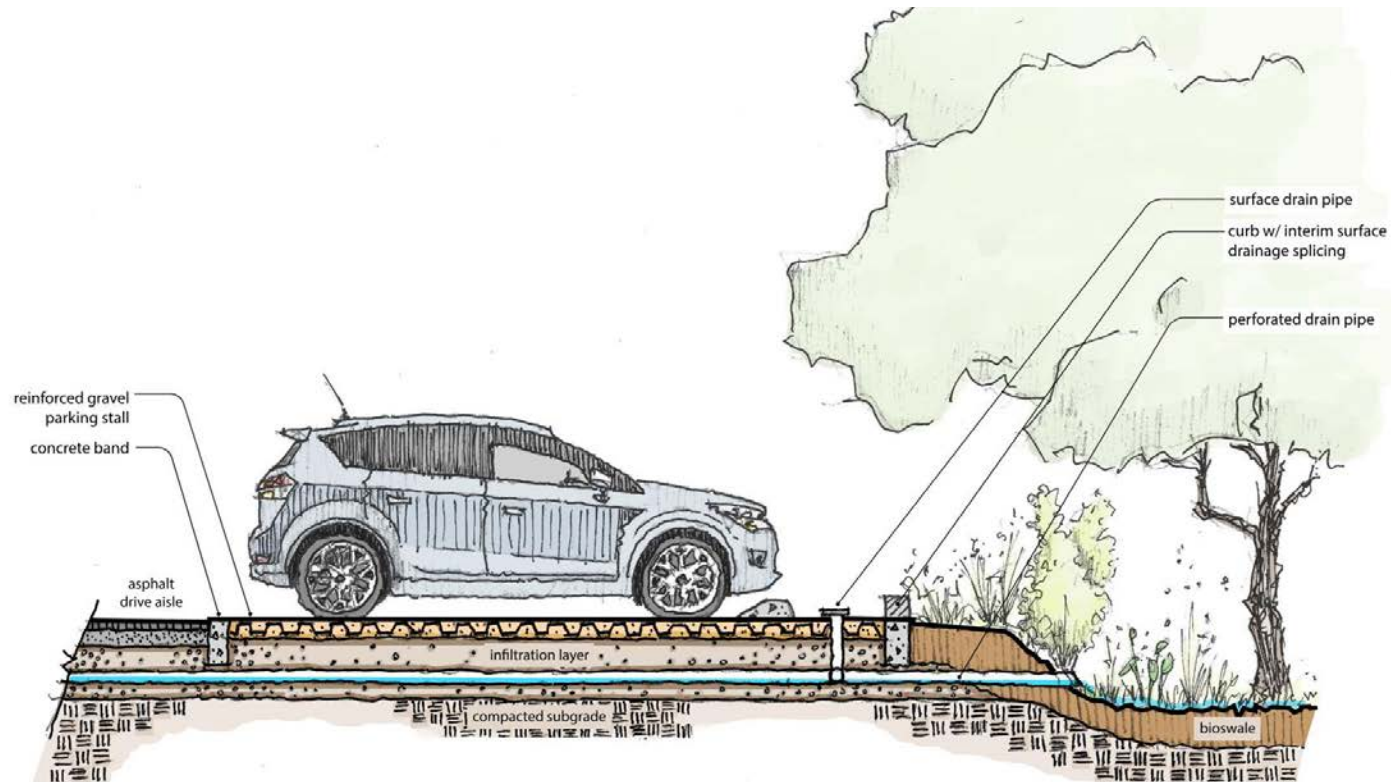


Figure 17: Interim Parking Lot Design Concept



4. Landscaping of Interim Parking Lots shall include irrigated above-ground planters with shade trees installed to reduce the urban heat island effect. In-ground planting and irrigation of shade trees within these lots is encouraged, with the intent of transplantation when development of the sites take place. At least one such tree for eight (8) parking spaces shall be provided. Paving of interim parking lots should consider use of permeable surfaces, such as gravel over a geo-grid.
5. Surface parking lots will not be permitted on Parcels 2 or 4. Surface parking is permitted on Parcel 7 only if the parking is completely encapsulated within the block, screened from public view by perimeter development (e.g., “garden-urban” multifamily residential).



*An example of a surface parking lot with pervious pavement system (Odette Winery - Napa, CA).*

### 3.10 SERVICE AND LOADING

All service areas (e.g., loading docks, garbage and recycling rooms, mechanical areas, storage, utility, meter rooms, etc.) must be architecturally-integrated within the body of the building or architecturally-screened from all public areas and located to the maximum extent practicable on frontages other than those designated as Pedestrian-Priority. Curbside, on-street loading areas up to 50 feet in length will be permitted along all street frontages except for FM 685.

Trash and recycling pick-up must be from internal rooms or enclosures, as dumpsters and bins will not be permitted to be stored or staged along any of the designated frontages or public rights-of-way. Trash haulers shall be required to retrieve and return such containers from and to internal trash rooms or enclosures.

### 3.11 SITE LANDSCAPING

Landscape plantings in the form of native grasses, shrubs, or perennials shall be provided with each building at time of site development and at a quantity which enhances the proposed development. Plantings may be provided along building foundations and between sidewalks and building edges in landscape beds with a variety of ground cover material to enhance the character of the building, establish a sense of place, reduce water use and enhance the micro climate. A variety of textures, height, color, smells, are encouraged to enrich the site. Trees installed as street trees with the development of each lot shall satisfy the required tree installation per lot, with the exception of any screening otherwise required herein.



# 4

## Building Design Standards

Design standards in this chapter describe the character and treatment of buildings and parking facilities within Downtown East, including requirements for facade design, corner and terminus elements, primary and accent building materials, roof treatments, parking garages and lots, and ground-level commercial and residential frontages.

## 4.1 BUILDING DESIGN PRINCIPLES

Pflugerville's Comprehensive Plan envisions a community with a "small-town feel", distinct from its neighboring cities. As such, Downtown East will be designed with low and mid-rise buildings that engage the public realm in a way that promotes a strong civic identity, community interaction and a friendly pedestrian environment. Buildings within Downtown East shall be designed:



- To engage pedestrians at the sidewalk level with interesting storefronts, outdoor cafes and/or residential stoops;



- To include facades with variation and interest that avoid monolithic and undifferentiated architectural volumes;



- To conceal parking and service areas from prominent public view; and



- To extend the historic fabric and scale of Downtown eastward across Railroad Avenue.

In keeping with this direction, the following design principles shall be incorporated into all buildings within Downtown East:

- Buildings shall be located and designed to define and enliven the District's network of streets and open spaces.
- Buildings shall introduce special elements at key corners and at visual termini to promote an interesting and legible townscape.
- The ground level of buildings shall promote an attractive, safe and interesting pedestrian environment; all building entries shall be oriented to the public sidewalk.
- Building massing shall be shaped and varied with multiple volumes that promote a small-town scale.
- Buildings shall be designed with care and craftsmanship, utilizing materials and treatments that achieve high levels of durability, energy and resource efficiency.
- Building elements that modulate harsh climatic conditions are particularly encouraged, such as canopies, awnings, shading and screening devices that create comfortable outdoor environments and that reduce building heat gain.
- Buildings shall employ traditional forms, materials and treatments that are vernacular to Central Texas communities, such as generous roof overhangs or canopies, punched window openings, stone and masonry, etc.
- Parking facilities shall be designed to avoid any obstruction of the pedestrian environment and to be largely hidden from view.



*Building elements that activate the pedestrian environment and provide shade are encouraged.*



*All building entries shall be oriented to the street.*

## 4.2 BUILDING FORM AND FACADE VARIATION

The intent of the following standards is to promote well-scaled and articulated buildings that contribute to the scale, interest and vitality of Downtown East. Buildings with large expanses of undifferentiated treatment or those lacking in volumetric variation are not permitted.

1. At intervals no greater than 150 feet in length along a street or open space frontage, buildings shall introduce a significant change in plane of at least five (5) feet in depth and ten (10) feet in width; this change should be used to create clear indentations in the building mass, resulting in distinctly different building volumes that help to achieve the desired town scale.
2. Variation in the parapet height, roof treatment, building material, window arrangement and/or other architectural treatments should also be introduced to accentuate these distinct volumes of the building.
3. Architectural elements including projecting bay windows, balconies (in a non-repetitive pattern) loggia, canopies, pediments, moldings, etc. should be used to further break up the mass of the building.
4. Walls more than 40 feet in length and with more than 1,000 square feet of surface area without fenestration are not permitted.
5. Buildings should provide four-sided and volumetric architecture, with materials that wrap around corners to reinforce the three-dimensionality of the structure; material changes should always occur with a change in plane, and never on outside corners.
6. The architecture should provide delineation between the building's base, its upper levels and the roof silhouette.
7. The facade should introduce a varied and non-repetitive composition of window-openings. Window openings should be recessed within the wall by at least 1.5 inches to emphasize the materiality and solidity of the building. Curtain walls should be limited in use and utilized only where they contribute positively to the architectural integrity of the building and adjacent open space.



*Large projects should be designed to create multiple building volumes with no building volume greater than 150 feet in length.*



*An exposed garage treated with high quality materials and treatments*



*A distinct corner element*



*Elevated ground-level residential dwelling units with street-oriented stoops*

## 4.3 PARKING GARAGE TREATMENTS

Along frontages where they are permitted to be exposed or visible, parking garage facades should be designed with high-quality materials and treatments that complement the primary building. The treatment should provide similar levels of articulation, avoid views to parked vehicles and shield interior lighting from the predominant public view. Rooftop lighting should also be designed so as not to be visible from any public street or open space within the District. To the maximum extent practicable, sloped floors and ramps should not be visible from a street or open space frontage.

## 4.4 CORNER AND TERMINUS ELEMENTS

Buildings that occupy significant corners or that terminate key views along streets should introduce special architectural elements (e.g., towers, cupolas, gables, dormers, balconies, etc.) to reinforce the legibility of the District and to promote a varied and interesting streetscape.

## 4.5 GROUND LEVEL RESIDENTIAL

Ground-level residential dwelling units along a street shall be elevated at least 18 inches but no more than 60 inches from the elevation of the sidewalk to provide privacy and separation. Residential unit entries, porches and stoops should be located along street and open space frontages to the maximum extent practicable. These street-oriented entries are secondary to internal entries within the buildings that meet applicable accessibility requirements. Stoops and porches should be designed to complement the streetscape with integrated planters, high quality railings and generous overhangs.

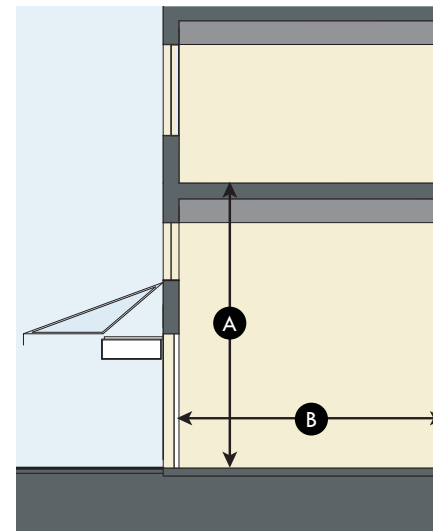
## 4.6 GROUND-LEVEL COMMERCIAL AND “RETAIL-READY” TREATMENT

Where required as per the standards of Chapter Three, ground-level commercial space should be designed in a manner suitable for retail uses with the following characteristics:

1. A floor-to-floor height of no less than 16 feet;
2. A usable floor area with a depth no less than 30 feet;
3. Primary entrances oriented to the street or open space at intervals no greater than 50 feet; and
4. High-quality storefront glazing systems (e.g., painted, front-loaded aluminum or steel, flush-glazed or butt-glazed systems) with a Visual Transmittance Rating (VTR) of 0.6 or higher, and a minimum storefront to building wall ratio of 75%, as measured along the street front of the ground-level facade between two and eight feet above the sidewalk;
5. High-quality, first-story accent materials such as stone, precast concrete, decorative terra cotta, brick, masonry, painted ornamental steel, stainless steel, chrome or bronze; and
6. Projecting awnings and/or canopies that provide weather protection.



A “retail-ready” ground-level tenant space



- A 16 feet minimum floor-to-floor
- B 30 feet minimum depth of usable space
- C Minimum 75% storefront glazing to building wall ratio between 2 feet to 8 feet above sidewalk
- D Approved High-quality Building Material (e.g., masonry, stucco, fiber-cement panels, etc.)
- E Projecting Awning or Canopy
- F High-quality Accent Material

Figure 18: Ground Level “Retail Ready” Treatment



## 4.7 BUILDING MATERIALS

The purpose of this section is to encourage high-quality, durable materials with aesthetic appeal which will promote compatible and cohesive design, grounded in the spirit of Central Texas.

A range of approved building materials may be used within the Downtown East district, including Texas limestones, granites or sandstones in light or warm tones, smooth-finished brick, painted brick, smooth-finished stucco, light-colored precast concrete, fiber-cement panels and/or other high-quality materials that the Planning Director deems to be compatible and complementary.

The following materials are not permitted:

- Exterior Insulation and Finish System (EIFS)
- Plastic or vinyl siding
- Plywood
- Wood fiber (oriented strand board)
- Under-fired brick or unfired clay, sand or shale rock
- Highly-reflective or “mirror” glass
- Cement board stucco

Building materials should be deployed to accentuate the three-dimensionality of the building facade. Changes of material should always occur at a distinct change in planes and never along the same plane or on an outside corner.

## 4.8 ROOF TREATMENT

Buildings may employ flat or sloping roofs, however, sloping roofs are particularly encouraged on buildings of three floors or fewer. Sloping roofs should be designed with generous overhangs, projecting eaves, exposed beams and decorative brackets. Standing seam metal roofs or concrete or clay tile in warm colors are encouraged.

Decorative building parapets or projections that provide distinctive silhouettes should be considered for flat-roofed buildings, with projecting parapets returning at least six feet to create a three-dimensional appearance from ground level view. Flat roofs should incorporate high-albedo reflective coatings. Rooftop mechanical equipment should not be visible from public streets, open spaces, or from neighboring single-family properties. Mechanical penthouses should be architecturally-integrated within the overall composition and vocabulary of the building.

Roofs should be designed to support rainwater capture and collection in tanks or cisterns for non-potable uses including site irrigation. Roofs should also be designed and oriented to allow for solar collection with photovoltaic panels, and buildings should be constructed to be “solar-ready”.



*Variation in roof treatment and parapet height can create a distinctive silhouette and interesting townscape.*



# 5

## Streetscape Design Standards

Streets represent a significant proportion of the public space of Downtown East and play a critical role in defining its character and sense of place. Main Street will be particularly important, providing a linear streetscape leading from Downtown and the trail network along Gilleland Creek to the Civic Plaza at the heart of the District. The standards in this chapter are intended to give developers, architects and landscape architects standards and material specifications that will help create a consistent, attractive and maintainable streetscape.

## 5.1 STREETScape DESIGN PRINCIPLES

The following principles outline the overall approach to creating a streetscape design that is functional and safe, and that promotes a sense of community, environmental responsibility and economic vitality:

- Streets within the District shall balance through-movement of automobiles with the safety and convenience of pedestrians.
- Vehicular traffic will move through the District in an orderly manner between FM 685 and Historic Downtown Pflugerville. Traffic-calming measures should be employed to prioritize pedestrian safety (e.g., narrower lanes, bulb-outs and raised crosswalks).
- Streets will reinforce a “park-once” behavior, by providing a safe, comfortable and interesting pedestrian environment that connects multiple destinations.
- Integrating universal design solutions will ensure accessibility for everyone, regardless of age and ability, by considering elements like safe curb-cuts, ramps and accessible sidewalk widths.
- All streets will be lined with trees to provide a shady canopy above the sidewalk.
- Planting of trees shall follow high-quality standards for both nursery stock and available healthy soil to ensure their ongoing health and longevity.
- Sidewalks shall be organized to include a curbside furnishing and street tree zone with an unobstructed promenading zone.



- Opportunities for sidewalk cafés and retail extension areas are encouraged along Main Street, the Civic Plaza and adjacent to commercial building frontages.
- Residential stoops and porches will be provided along ground level residential frontages.
- The streetscape will be constructed to allow for predictable and cost-effective maintenance.
- Local strategies toward climate adaptation shall inform the design of the streetscape to improve its resilience to extreme weather events.

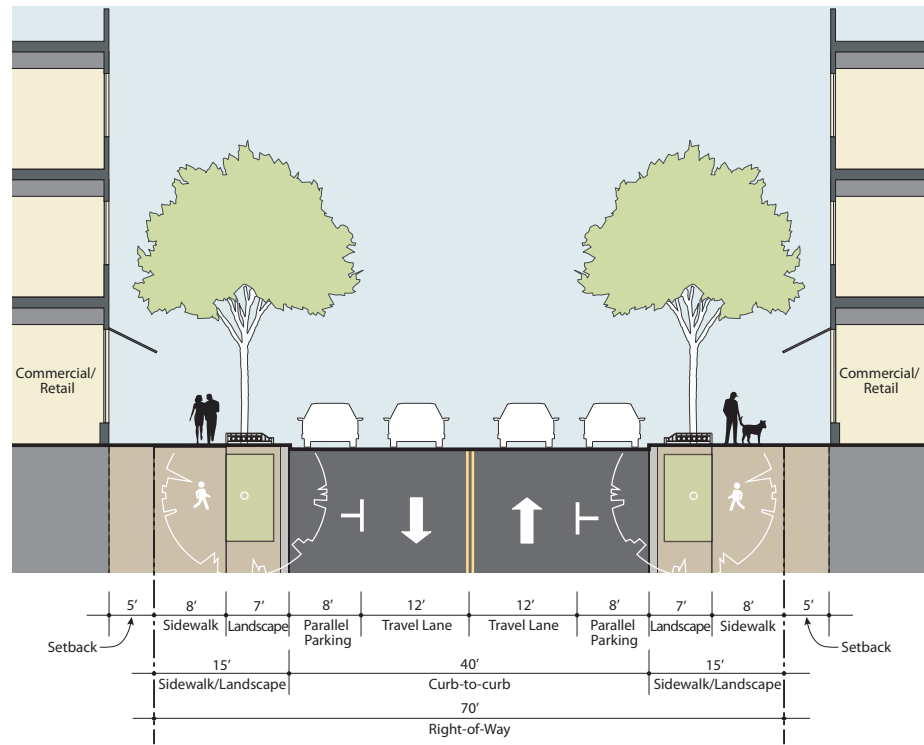
## 5.2 STREET NETWORK & CROSS-SECTIONS

While Main Street forms the principal spine connecting Downtown with FM 685 and the HEB supermarket, Downtown East will also include a parallel street to the north and a connecting north-south street and promenade, resulting in a series of blocks, many oriented to the Civic Plaza. The frontage along FM 685 will also be reconfigured to create an attractive, eastern edge to the District and one that is more hospitable to pedestrians and cyclists. Chapter 6 describes the network of existing and planned trails that will link the streets of Downtown East to the surrounding city.

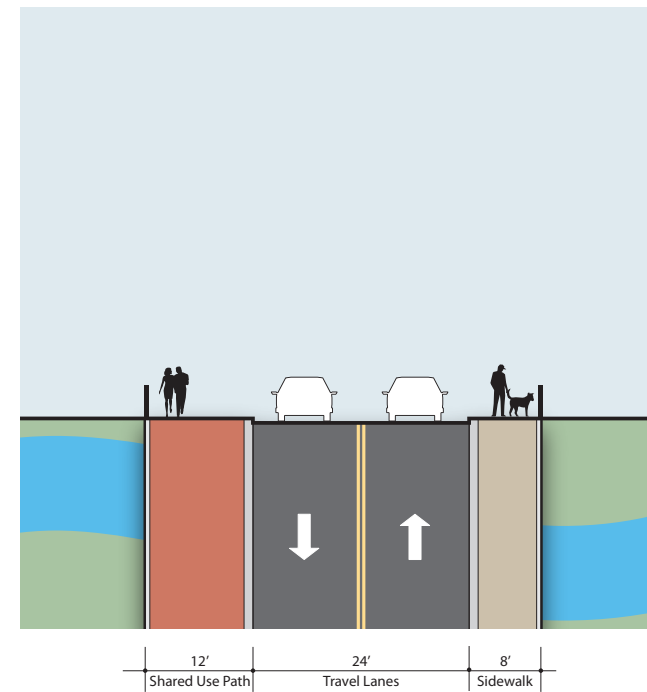


Figure 19: Key Map of Street Cross-Sections

## MAIN STREET



## MAIN STREET BRIDGE



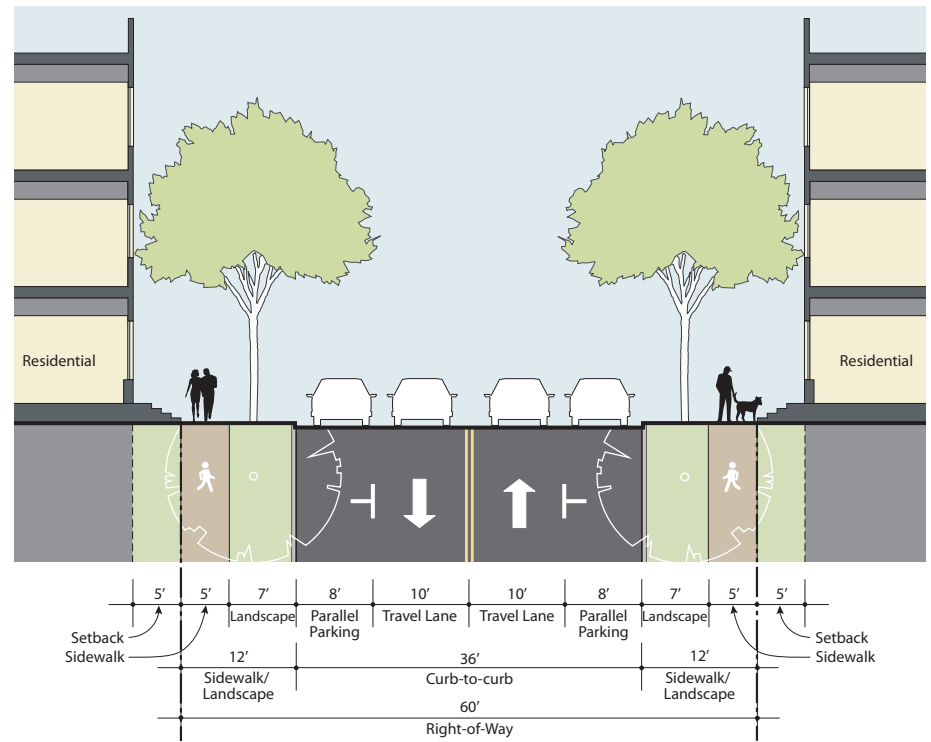
**Main Street (70-ft ROW):** Main Street will provide two vehicular lanes of travel between Railroad Avenue on the west and FM 685 on the east, with a left turn lane at the FM 685 intersection. Curbside parallel parking will be provided along the length of the street interrupted by pedestrian bulb-outs at intersections and the Civic Plaza to create safer and shorter pedestrian street crossings. The “back-of-curb” area will include a promenade zone with a minimum width of eight (8) feet and a street tree and furniture zone of seven (7) feet along the curb edge. Building setbacks with a minimum dimension of five (5) feet will provide additional space for promenading and outdoor cafe seating (Figure 20). The Main Street Bridge over Gilleland Creek will provide two vehicular travel lanes with a shared-use path (SUP) of 12 feet in width on the north side and an eight-foot wide sidewalk on the south side (Figure 20).

Figure 20: Cross-Sections of Main Street

## B STREET



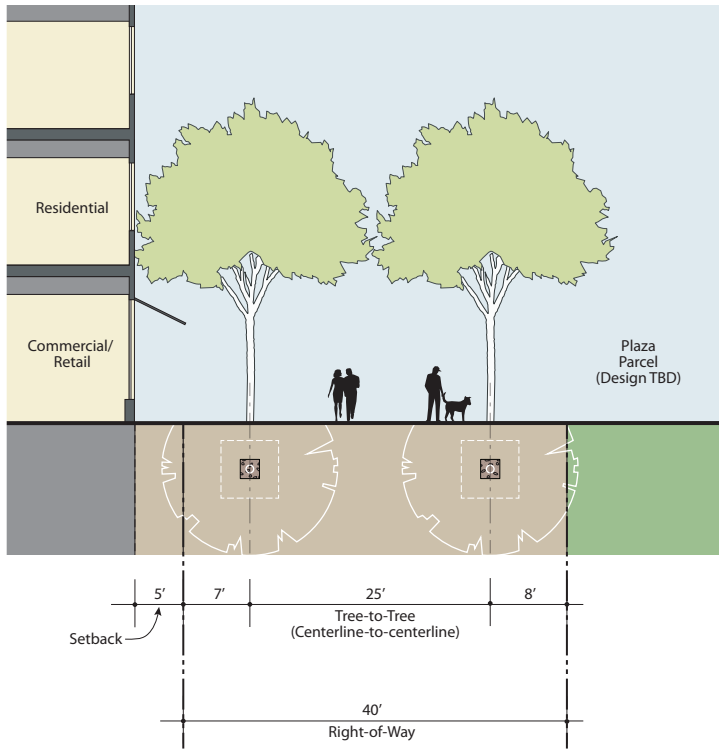
## C STREET



**Secondary Streets (60-foot ROW):** B and C Streets are more intimately scaled as two-lane roadways with 10-foot travel lanes and curbside parallel parking. The back-of-curb condition includes the same tree and furnishing zone as described for Main Street, but with a narrower five (5) foot wide sidewalk. A minimum building setback of five (5) feet allows space for additional landscaping as well as stoops or porches for ground-level residential units (Figure 21).

**Figure 21: Cross-Sections of Secondary Streets**

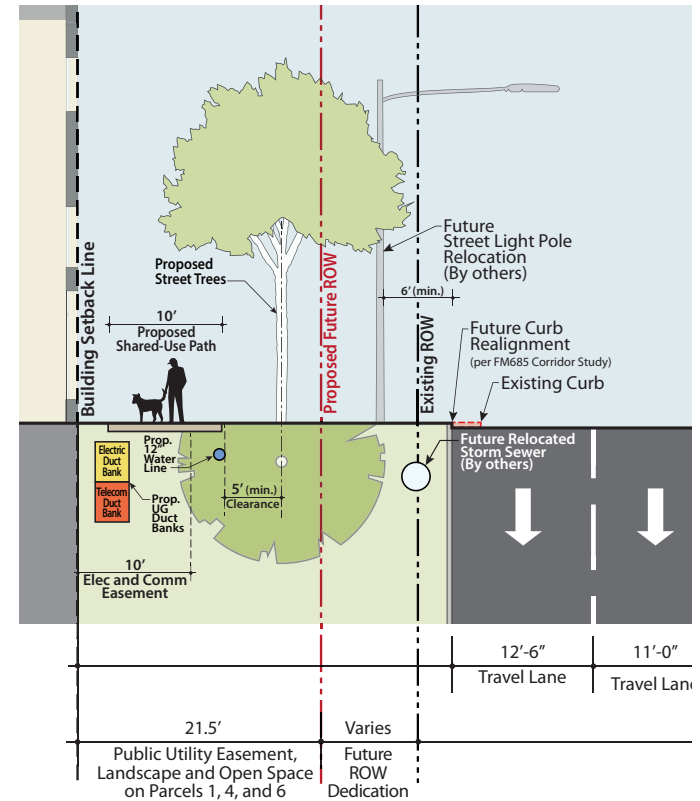
## D STREET



**Civic Plaza Promenade (40-foot ROW):** D Street along the west edge of the Civic Plaza is designed as a tree-lined pedestrian promenade that provides north-south connectivity within the District. This space can accommodate emergency vehicles, food trucks and farmer’s market tents and trucks. The space is envisioned as a curbsless street with bollards or other barriers along its shared edge with the Plaza and a continuous canopy of shade trees.

Figure 22: Cross-Section of the Civic Plaza Promenade

## FM 685



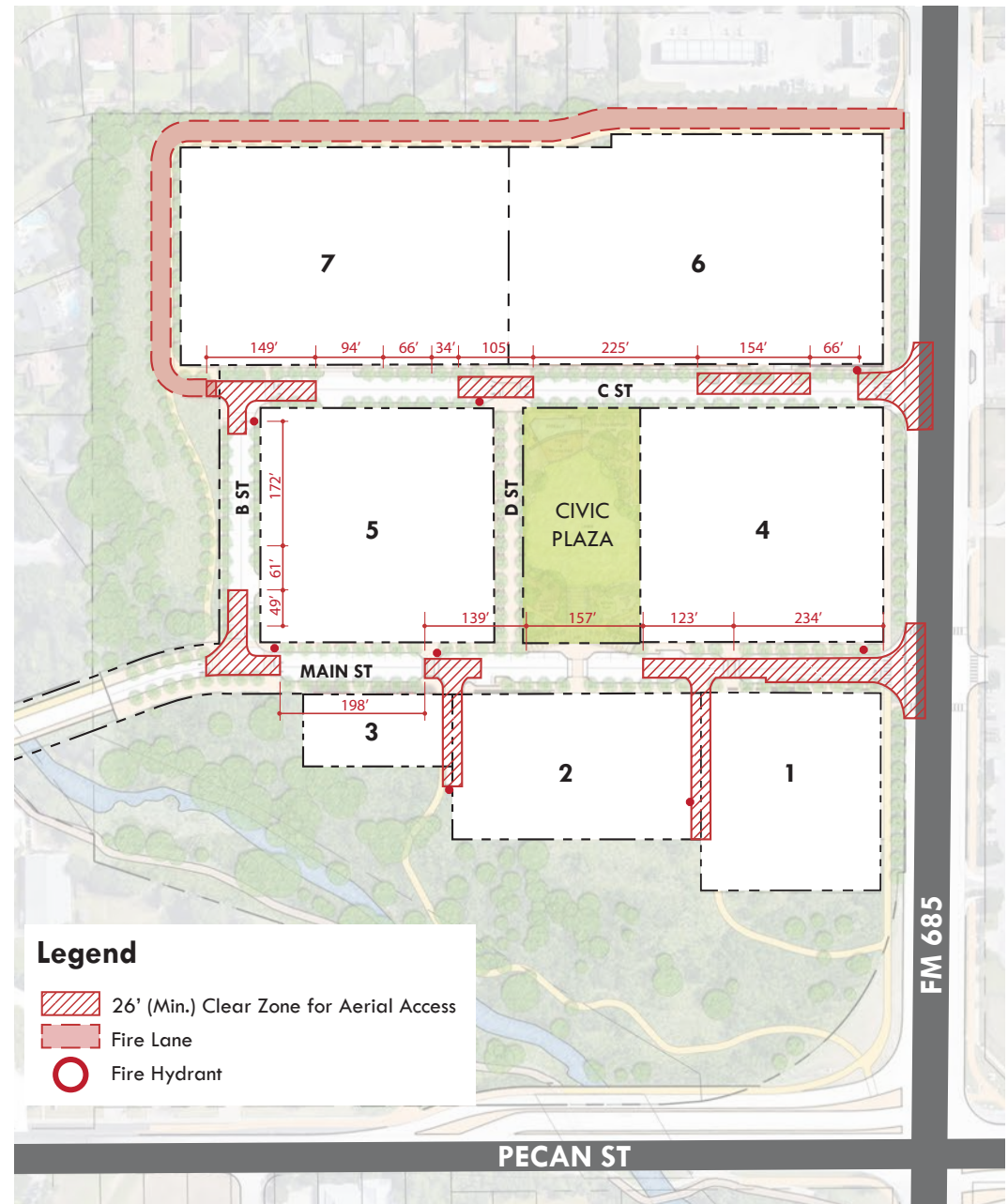
**FM 685 Frontage:** To accommodate the planned expansion of FM 685 from a four to six-lane roadway, approximately 10 feet of additional right-of-way will be dedicated to TxDOT. Behind that new right-of-way, a public utility easement (PUE) and linear open space will be established along the eastern property lines of Parcels 1, 4, and 6. Within that 30-foot zone, a shade tree will be planted between the TxDOT right-of-way and the PUE. A 10-foot wide shared-use path will be constructed within the PUE (Figure 23). Prior to the full construction of the six-lane roadway, a southbound deceleration lane into C Street is recommended to comply with TxDOT standards and in response to the initial results of the Traffic Impact Analysis (TIA). This deceleration lane will ultimately become the third lane when the full improvement is implemented by TxDOT.

Figure 23: Cross-Section of the FM 685 Frontage

**Fire Access:** The streets of Downtown East have been designed in collaboration with the City of Pflugerville's Fire Department to ensure compliance with the City's amendments to the International Fire Code (IFC).

A 20-foot minimum width clear zone is provided on all streets, and, as shown in Figure 24, a 26-foot clear deployment zone for aerial access is provided at frequent intervals along all block-faces. This is achieved at intersections and within blocks at driveways and by eliminating curbside parking on one or both sides of the street. A minimum effective turning radius of 28 feet is provided at all intersections, and each building will comply with the IFC standards for hose reach. Fire lanes integrated with the trail system provide fire access along the northern and western edges of the District, as described in Chapter 6.

**Sight Triangles:** Intersections shall comply with Chapter 9.8 of the Uniform Development Code, except that one curbside shade tree, limbed up to a height of at least 10 feet, will be permitted within the prescribed sight triangle.



**Figure 24: Fire Access Diagram** (Subject to Change in Coordination with City of Pflugerville Fire Department)



## 5.3 STREET TREES

A continuous canopy of street trees is a crucial part of a successful streetscape, creating a long-term, complementary relationship with the built environment. Street trees provide many benefits, including shade for human comfort, scale in relation to buildings, protected separation from moving vehicles, and environmental benefits related to water and air quality, as well as urban heat island mitigation. In order to maximize these benefits, it is important that the designs of individual segments of the street follow consistent spatial guidelines, and it is imperative to use the highest-quality planting details, irrigation and maintenance for the trees to thrive over time.

With regards to spatial requirements, the tree spacing and placement in relation to the curb are important factors for consistency and the form of the street. Street trees will be placed approximately 25 to 30 feet apart and will be set back from the curb by a minimum of four (4) feet. This spacing provides trees with enough access to light, adequate room for growth and a relatively continuous shade canopy. Adequate distance between street trees and the curbs is required to prevent the trunk from being struck by vehicle doors or overhanging bumpers. This distance also takes into consideration the size of the tree's root ball at the time of planting. Where a dimension of less than four feet between the tree and other hardscape elements is required, (e.g., adjacent to sidewalks and/or where paver grates are used) soil cells or structural soil will be required to achieve adequate soil volume.

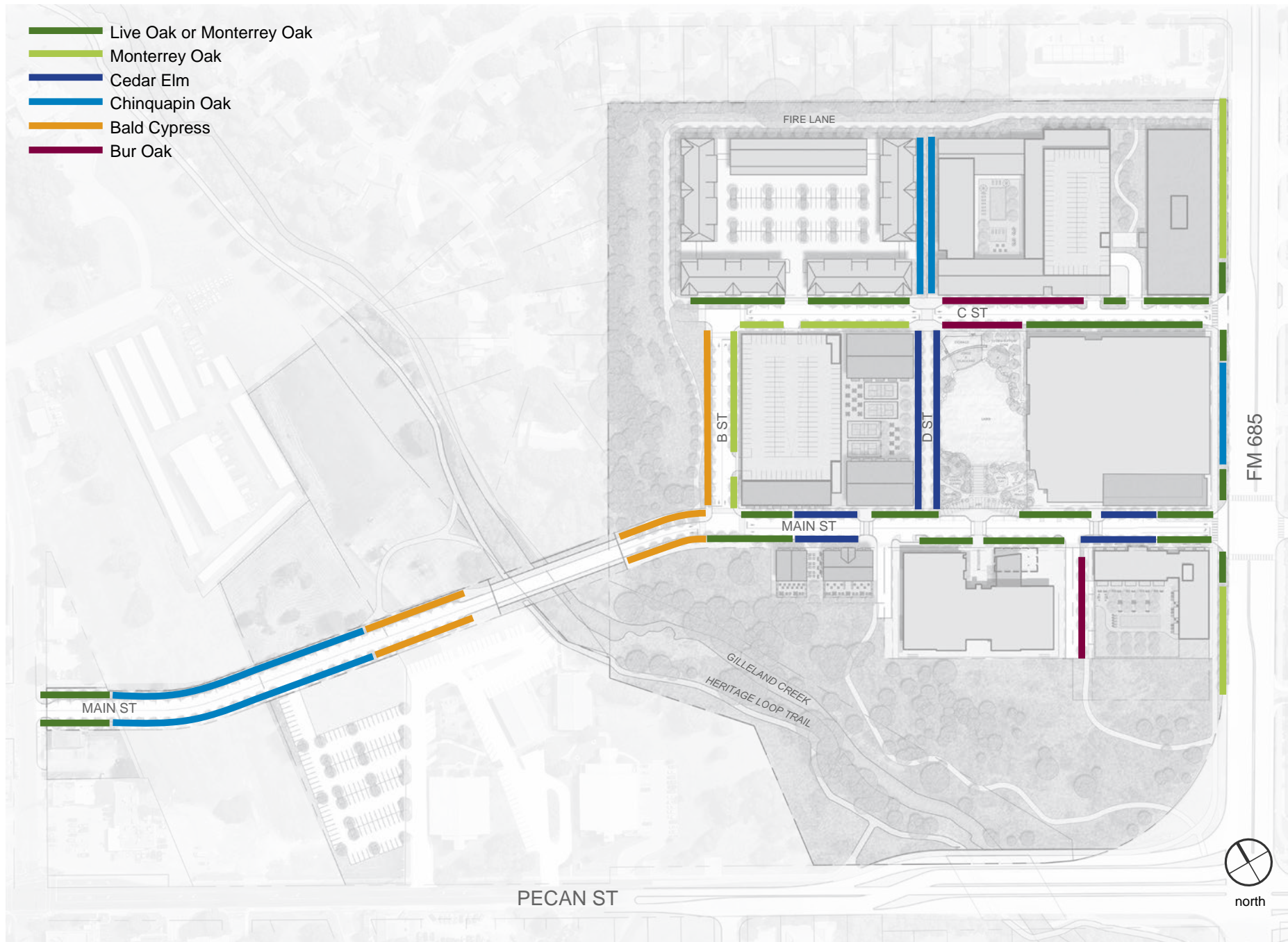
For trees, healthy soil and appropriate soil moisture are paramount to their establishment and long-term performance. Access to adequate soil volume is generally accepted by industry experts as the key indicator of a tree's success – especially in harsh urban environments. Street trees should have a continuous planting zone (trench) to allow the sharing of nutrients and moisture within the soil, as well as to establish a robust biological network. If a soil zone of this size cannot be fully exposed at the surface, then soil cells should be used under paved areas in order to achieve the goal of root zone continuity. A minimum of two root zone watering system emitters should be provided at each tree to deliver water across all levels of the root zone for a high-efficiency subsurface irrigation system. The subsurface bubblers are less likely to be buried or damaged by typical maintenance

procedures, and the below-ground placement helps water the roots more deeply and effectively.

The size and condition of the tree at the time of installation are also important to its long-term health and to the spatial definition of the street. All trees should be sourced from nurseries with good cultural practices, in terms of canopy pruning and root system development. No trees should have circling roots, and all root balls for trees should be pruned prior to installation. Trees with circling roots will have reduced stability because of limited lateral buttress roots. The circling roots can also girdle the trunk or other major roots of the tree over time, stunting its growth and thereby adversely affecting its health and vigor. To meet the spatial and access clearance needs of the streetscape, trees must have a single, straight leader (main stem). Trees should be approximately 16 to 18 feet in height with a bottom canopy clearance on the sidewalk side that meets the ADA (Americans with Disabilities Act) and the TAS (Texas Accessibility Standards) minimum code requirement of 80 inches, where branches overhang designated accessible routes along sidewalks or plazas.



*An example of a well-shaded promenade*



**Figure 25: Street Tree Map**

## Street Tree Species

Six tree species, all native or adapted to Central Texas, shall make up the streetscapes of Downtown East (see Figure 26), distributed as suggested on Figure 25.

## Street Tree Selection

The following factors should be considered in the selection, planting and maintenance of street trees:

- **Species:** Trees will be chosen as suitable for the local changing climate, soil type, mature size, and compatibility with surrounding infrastructure, such as utilities and sidewalks.
- **Aesthetics:** Trees that complement the desired character and aesthetics of the streetscape.
- **Functionality:** Trees that provide shade, wind protection or other desired functional benefits.
- **Growth habit:** Trees with a mature size appropriate for the available space, avoiding interference with utility or security equipment, buildings, or pedestrian walkways.

- **Disease and pest resistance:** Trees known for resistance to local diseases, root rot and pests.
- **Native:** Native species propagated and grown within the local region will be chosen whenever possible to promote biodiversity and ecological benefits.
- **Seed source:** The use of trees grown from seed stock of the Texas A&M Forest Service's Urban Tree Improvement Program (UTIP) is encouraged to provide genetically-superior trees proven to outperform in terms of survival, growth and adaptability.
- **Nursery stock:** Quality standards such as Urban Tree Foundation's "Strategies for Growing a High-Quality Root System, Trunk, and Crown in a Container Nursery" (Companion publication to the Guideline Specifications for Nursery Tree Quality) and The American Standard for Nursery Stock (ANSI Z60.1-2014) should be used to rate available nursery stock or establish quality standards for market-available and contract-grown trees.



### Cedar Elm

*Ulmus crassifolia*  
4" caliper  
16' height  
Yellow seasonal foliage

### Chinquapin Oak

*Quercus muehlenbergii*  
4" caliper  
16' height  
Yellow to bronze seasonal foliage

### Live Oak

*Quercus virginiana*  
4" caliper  
16' height

### Monterrey Oak

*Quercus polymorpha*  
4" caliper  
16' height

### Bald Cypress

*Taxodium distichum*  
4" caliper  
16' height  
Orange to red seasonal foliage

### Burr Oak

*Quercus macrocarpa*  
4" caliper  
16' height

Figure 26: Proposed Street Tree Species

## Planting

- **Soil quality:** Adequate soil volume, texture, and quality will support the chosen tree's natural root system. Biological inoculations from healthy, on-site soil fungi should be considered.
- **Spacing:** Trees shall be planted at appropriate distances from each other, sidewalks, buildings and underground utilities to avoid future conflicts.
- **Planting depth:** Trees will be planted at the correct depth, relative to adjacent grade and drainage patterns.
- **Anchorage:** Subsurface staking or subsurface guying devices should be installed to provide ample structural support of the tree's base to remain plumb, yet allow some movement without damaging the rootball or tree.
- **Watering:** Responsible irrigation and soil design will ensure adequate drainage and soil moisture retention to promote healthy growth.
- **Mulching:** Proper maintenance of mulch will help retain moisture, suppress weeds and regulate soil temperature.

## Maintenance

- **Pruning:** Trees shall be regularly pruned to maintain proper shape, to remove deadwood and to prevent interference with pedestrians and utilities. Appropriate pruning techniques specific to the chosen species shall follow ISA / ANSI standards.
- **Monitoring:** Trees shall be monitored on a regular basis for signs of disease, pests or damage and addressed promptly.
- **Infrastructure considerations:** Be mindful of potential conflicts with underground utilities and avoid planting trees directly over them.

## Additional Considerations

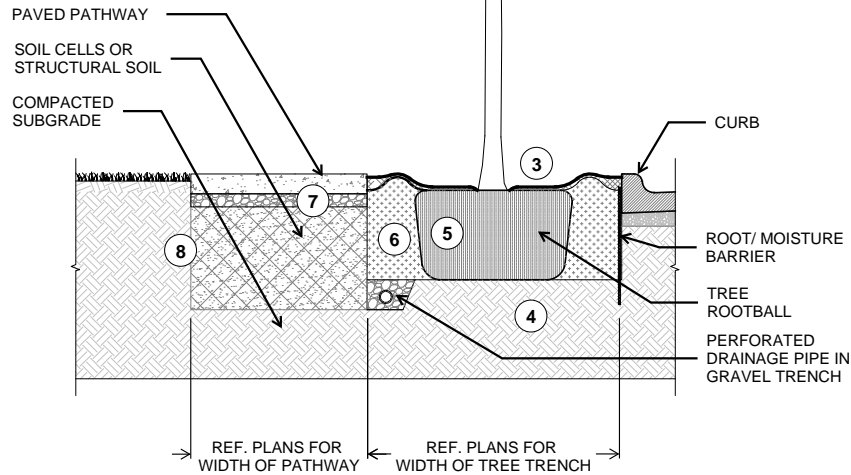
- **Tree protection during construction:** Enhanced tree protection standards shall be implemented to protect existing and proposed trees during construction activities to minimize root damage and ensure their survival.

# Street Tree Planting Detail

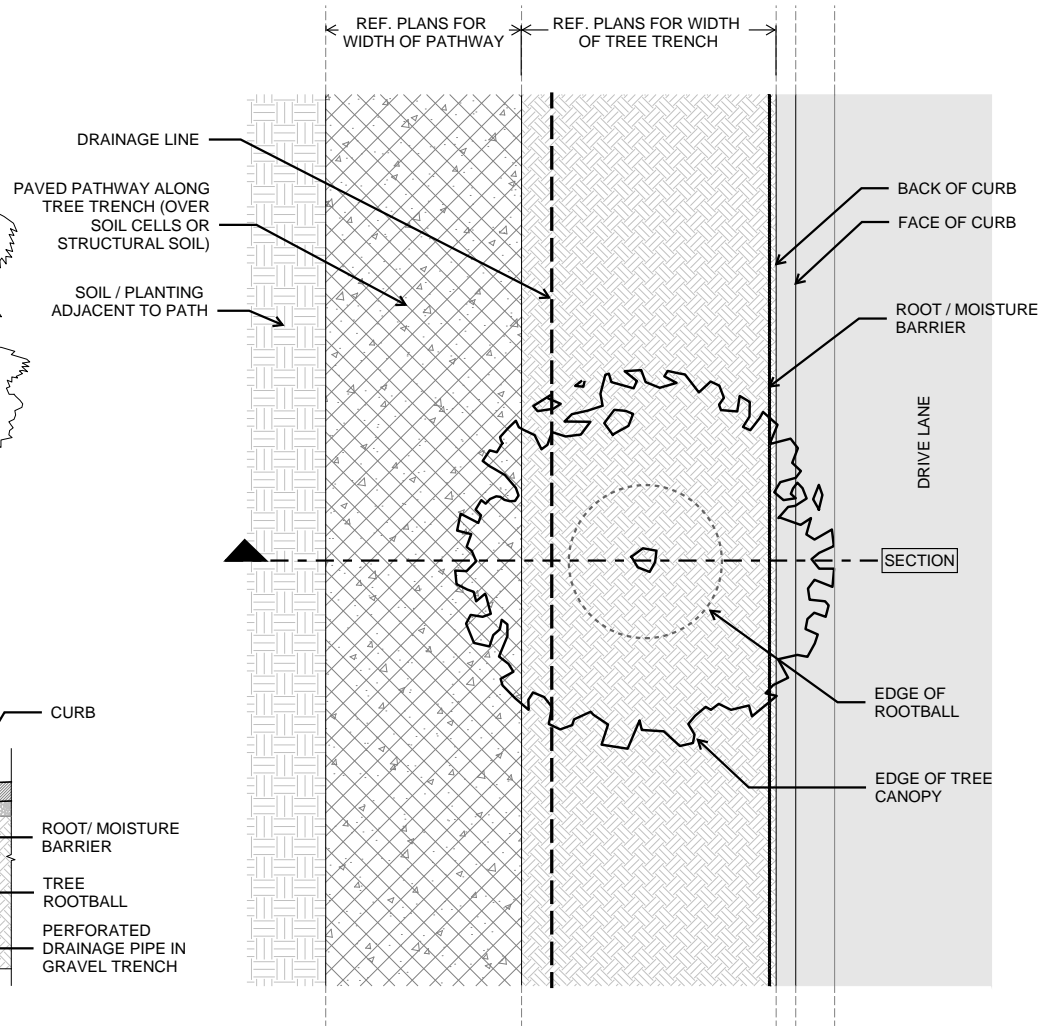
Proper street tree coordination and detailing before planting is crucial for establishing healthy, long-lived trees that will benefit the environment and the community with minimal conflicts. Figure 27 illustrates the recommended tree planting detail, showing the relationship between the proposed tree, its appurtenances and surrounding hardscape elements.

**KEYED NOTES:**

1. REMOVE NURSERY STAKE AND TAGS
2. ONLY PRUNE FOR MIN. ACCESSIBILITY CLEARANCES
3. TREES SHALL BE PLANTED WITH THE EXPOSED ROOT FLARE 1-3" ABOVE THE SURROUNDING GRADE. ALL SOIL ABOVE THE ROOT FLARE SHALL BE REMOVED. TAPER THICKNESS OF MULCH TO 1-2" OVER ROOTBALL, DO NOT COVER ROOT FLARE
4. UNCOMPACTED SUBGRADE
5. PRUNE ROOTS AROUND ENTIRE PERIMETER PRIOR TO BACKFILLING
6. APPROVED TREE PLANTING BACKFILL MIX
7. 2" ANGULAR GRAVEL (WITHOUT FINES) BENEATH PAVING (DO NOT USE SAND)
8. SCARIFY SIDES OF EXCAVATED EDGES OF TREE PITS / TRENCHES



SECTION



PLAN

Figure 27: Street Tree Planting Detail

## 5.4 SIDEWALK AND PAVING TREATMENT

As described in 5.2 above, there are two principal vehicular street types within Downtown East: Main Street with a 70-foot right-of-way, and the secondary streets (B and C Streets) with a 60-foot right-of-way. D Street is a pedestrian promenade. The back-of-curb sidewalk areas on both vehicular street types include a Promenade Zone and a Street Tree/Furniture Zone with varying treatments as follows:

**Main Street, East of B Street**, forms the main pedestrian spine of Downtown East's civic, retail and entertainment district, and is recommended for the highest levels of streetscape treatment. As shown in Figure 28A, this segment of Main Street should utilize a decorative pavement treatment (e.g., stamped concrete, concrete or masonry unit pavers, permeable pavers), interrupted by tree leave-outs containing ground cover and defined by tree guards. In areas with high levels of pedestrian activity or outdoor seating, paver grates may be used instead of the planted leave-outs. A 12-inch wide curb is recommended along this segment of Main Street to provide a "step-out" from on-street parking and/or the roadway level.

**Main Street, West of B Street** should utilize the same planted leave-outs as described for the eastern segments of Main Street, but a broom-finish concrete sidewalk is recommended for the Promenade Zone. The same decorative pavement treatment utilized on the eastern segments of Main Street is recommended in the Street Tree/Furniture Zone between the planted leave-outs, per Figure 28B.



Figure 28A: Main Street, East of B Street



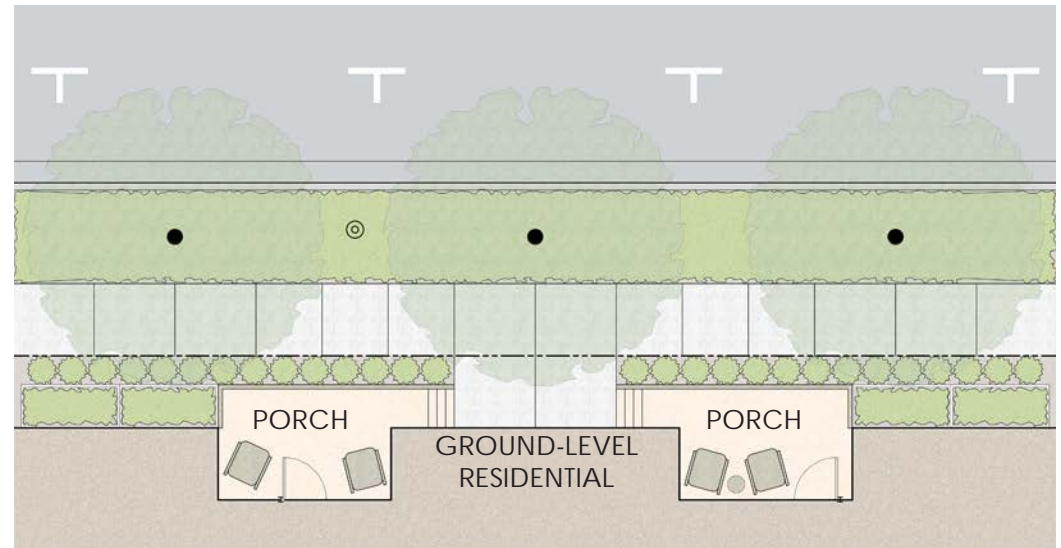
Figure 28B: Main Street, West of B Street

**Secondary (B & C) Streets:** Along secondary streets, sidewalks within the Promenade Zone should be paved in broom-finish concrete, while the Street Tree/Furnishing Zone should be a continuous planting strip with ground covers and/or low grasses. In areas where there is more intensive activity (e.g., opposite or adjacent to the Civic Plaza), tree leave-outs are recommended in place of the continuous planting strip. Where a continuous planting strip is installed, intermittently-placed stepping stones should be introduced to provide paved access between parallel parking spaces and the sidewalk, per Figure 29.

**D Street/ Civic Plaza Promenade:** The promenade along the west edge of the Civic Plaza should utilize the same decorative pavement treatment as specified for Main Street. Street trees should be installed in paver grates and spaced at least 25 feet apart to accommodate two, 10-foot by 10-foot pop-up tents for farmers market or festival days, per Figure 30. Street lighting poles will be placed in line with street trees, equidistant between trees.



*A tree-lined pedestrian promenade (Aldrich Street Paseo in the Mueller Neighborhood, Austin, Texas.)*



**Figure 29: B & C Streets**



**Figure 30: Civic Plaza Promenade**

**Pedestrian Crosswalks:** The main field of the crosswalk should be integral-color concrete, bordered by a one-foot wide band of lighter gray concrete on both sides. Curb ramps will include detectable warnings made of cast iron. Speed table crosswalks are recommended between the Civic Plaza and City Hall to calm traffic and to provide for safe passage of pedestrians.

**Street Tree Electrification:** Each tree along the entire length of Main Street and those along D Street (the Plaza Promenade) shall include a duplex electrical receptacle to allow for decorative and seasonal lighting. These should be provided in 110V electrical outlets with exterior-rated metal in-use covers. Where market or other vendors may be present, a dedicated 20A circuit is recommended.



*Electrified street trees provide additional opportunities for lighting.*

## 5.5 TIMING AND RESPONSIBILITIES FOR STREETSCAPE

Streetscapes including trees, paving and furnishings will be installed in a phased manner. During the first phase of development (Figure 4), the following streetscapes shall be completed by Griffin | Swinerton:

- Main Street improvements adjacent to the planned City Hall, Civic Plaza, Recreation Center, and the parking lots on Parcels 1 and 3;
- Main Street improvements between the Main Street Bridge and Railroad Avenue; and
- C Street improvements adjacent to the Recreation Center, Civic Plaza and the parking lot on Parcel 6.
- The remaining frontages shall include temporary sidewalks that could be of crushed gravel or other material that provides an accessible path of travel.

Subsequent phases of the streetscape shall be installed by the vertical developer of the adjacent property. Ongoing maintenance of the streetscape shall be the responsibility of the Property Owners Association and/or the developer.



## 5.6 DRIVEWAYS AND CURB CUTS

Driveways and curb-cuts are not permitted on Pedestrian Priority frontages.

Curb-cuts and driveways shall be no more than 25 feet in width, with the exception of driveways directly serving structured parking garages, but in no case shall these exceed 40 feet.

Permitted driveways shall ramp up to the level of the sidewalk, so that the sidewalk and its treatment remain consistent across the driveway.

## 5.7 STREET LIGHTING

West of Gilleland Creek, the Downtown historic decorative light fixture shall be installed to provide continuity with the existing fixtures along Main Street. Throughout the Pfluger Tract, a contemporary version of the Downtown fixture is recommended, such as a full cut-off, post-top fixture. Coordination with Oncor, the electric utility provider for the Downtown East site, on the selection of the final fixture will be required.

In addition to street lighting, provision should be made for festoon or decorative lighting within and between trees along Main Street and the Plaza Promenade (D Street).



*An example of a curb cut at a structured parking entrance that ramps up to the level of the sidewalk so that the sidewalk and its treatment remain consistent across the driveway.*

## 5.8 STREET FURNISHINGS

Street furnishings within the Downtown East District shall compliment the City's existing range of furnishings currently used within the Downtown District Overlay and by the Parks and Recreation Department while providing a distinct, contemporary aesthetic. It is recommended that furniture placement be judicious so that the District does not feel cluttered with too many furnishings. The following section describes preferred qualities and materials for street furnishings and provides furnishing selections that exemplify these qualities.

### Bench - Urban

Urban Benches are preferred to primarily consist of a unified, single wood material for the bench and backrest components and a unified, single steel material for the bench supports and armrests in a black powder-coated finish. Wood materials for benches are desired to exist within the urban setting to represent the concept of the adjacent natural setting of the Greenway and Creek infiltrating into the urban setting and providing a direct human-nature connection. Surface mounting is the preferred method of installation for this furniture piece.

Thermally modified Red Oak is the preferred wood material for this bench as it provides a more sustainable lumber option than the Ipe alternative, however both lumber options are of high-quality and high-durability.

### Bench - Trails

Trail Benches are preferred to primarily consist of a unified, single wood material for the bench and backrest components and a unified, single steel support material in a black powder-coated finish. Support posts embedded in a buried concrete footing is the preferred method of installation to minimize interruptions to finished grade and revegetated surfaces in more naturalized areas.

Thermally modified Red Oak is the preferred wood material for this bench as it provides a more sustainable lumber option than the Ipe alternative, however both lumber options are of high-quality and high-durability.

### Bench - Urban Alternate

The City Standard steel bench in a black powder-coated finish is considered an acceptable option for the urban setting. However, it would be preferred

that this bench be considered an alternative option to the thermally modified wood bench specified above. Due to the nature of black metal being a heat conductor in exposed settings where shade is minimal, it preferred that this alternative only be used in an urban setting where shade is ample and/or shade trees are present.



**Bench - Urban:** DuMor 6' Bench, Thermally Modified Red Oak, 270-60TMR



**Bench - Trail:** DuMor 6' Bench, Ipe, 79-601



**Bench - Urban Alternate:**  
Park Warehouse 6' Steel Strap Bench with Straight Back, 622BE115  
(Pflugerville Parks & Rec Department Standard Furnishing)

### Steel Bollard - Urban

Steel bollards in black powder-coated finishing are the preferred bollard furnishing for the urban setting. Bollards located for pedestrian protection from vehicular traffic shall be installed to meet minimum safety standards.

### Wood Bollard - Trails

Wood bollards are the preferred bollard furnishing for necessary trail-user protections in the Greenway and Gilleland Creek setting. Wood bollards shall not be utilized in settings where pedestrian protection from vehicular traffic is the primary function for the furnishing.

### Bike Rack

The Inverted U Bike Rack has long been considered the preferred standard for Bicycle Parking in urban settings. It's functional simplicity is highly desired by the cyclist community and provides a clean/ succinct cost-efficient solution for bicycle parking in the urban setting. A silver powder-coated finishing is preferred to match a unified color for the furnishing palette.

Bike racks within public rights-of-way shall be located between tree plantings within the landscape zone of the street (see cross-sections in section 5.2). Bike racks located outside public rights-of-way shall adhere to the requirements of UDC 10.7.

### Trash Receptacle

City Standard furnishing. No change proposed.

### Recycling Receptacle

An additional recycling receptacle is proposed in the same design style as the City Standard trash receptacle and shall be paired with trash receptacle locations in all instances. Blue powder-coated finish is preferred to identify this receptacle's function from a viewing distance.



**Steel Bollard - Urban:**  
*DuMor Bollard 400, black*



**Wood Bollard - Trails:**  
*6"Ø Pressure treated wood bollard w/ 3" radius top (Pflugerville Parks & Rec Department Standard Furnishing)*



**Bike Rack:** *Inverted U Bike Rack, silver powder coat*



**Trash Receptacle:** *Park Warehouse Flare - Top Trash Receptacle w/ Door, 622TR120-1, black (Pflugerville Parks & Rec Department Standard Furnishing). Pflugerville standard trash receptacle must be paired with recycling receptacle of same family, blue color*

## 5.9 OUTDOOR CAFE ZONES

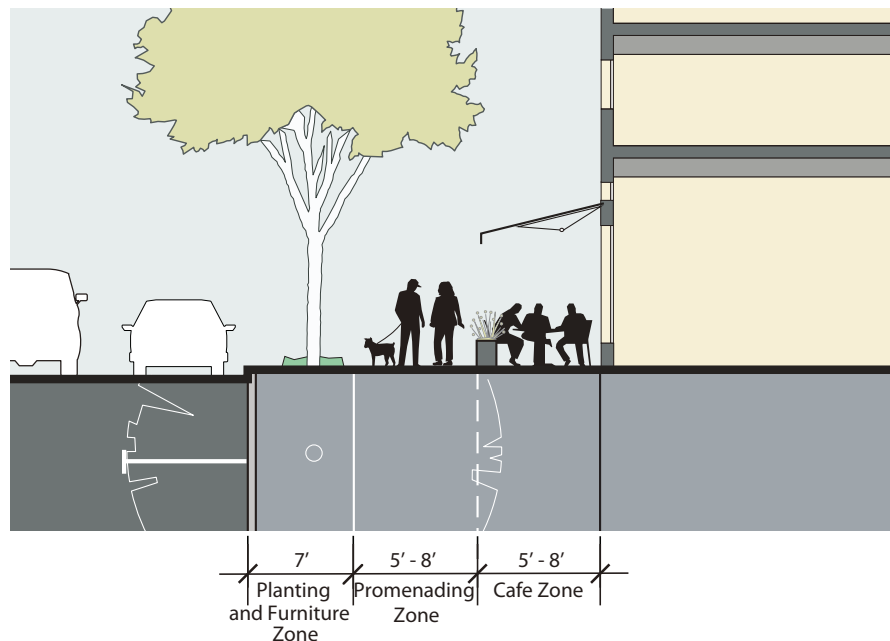
Outdoor dining is encouraged throughout Downtown East, but in particular along the Pedestrian-Priority frontages, where streets have the greatest combination of sidewalk widths and setbacks to accommodate café zones. The following provides standards for the treatment of all café areas:

**Promenading Zone:** Cafés shall maintain an unobstructed walking or through-zone with a predominant width of eight (8) feet but no less than five (5) feet (see Figure 31).

**Café Zone:** The depth of the café zone will depend on the available area between the promenading zone and the building front, but should be no less than five (5) feet. Where cafés encroach into the public right-of-way (i.e., promenading zone) a license agreement with the City of Pflugerville will be required.



*A cafe area with raised planters and canvas umbrellas.*



**Figure 31: Main Street Outdoor Cafe Zone**

**Permanent Improvements:** Unless the site developer or a future building tenant obtains approval from the City of Pflugerville, no permanent improvements (e.g. barriers, trellises, structures, etc.) or sidewalk modifications will be permitted. Proposed improvements on sidewalk modifications will be reviewed and approved on a case-by-case basis.

**Umbrellas:** Individual canvas or other non-vinyl umbrellas of a compatible design may be permitted in café extension areas, but shall not extend into the promenading zone. Umbrellas shall be made for outdoor commercial use.

**Furniture Materials:** Tables and chairs will be of a high-quality, suitable for exterior use with metal, plastic, and/or durable and weathering woods. All tables and chairs shall be movable, i.e., none will be permitted to be bolted or affixed to the sidewalk. All furniture shall be a robust, commercial grade and manufactured and constructed for outdoor use.



*Movable planters provide the cafe with an attractive separation from the promenading zone.*

**Planters:** Box or other shaped planters may be used to define the boundaries of the café seating area. To avoid blocking the patron’s vision while seated, the combined height of the planters and live plants shall not exceed 40 inches from sidewalk grade. The planters shall be no greater in height than 30 inches and no wider than 24 inches at the base. Taller plants may be permitted, depending on the location of the sidewalk café.

All planters should be made of safe, durable and attractive materials such as wood and steel. All planters must be irrigated and planted year-round. The café or business owner shall be responsible for the prompt removal of all poorly-maintained plantings and the installation of healthy plant material. Drainage of planters shall be controlled so that drainage doesn’t occur on sidewalks.



*Retractable fabric awnings that provide shade and color are particularly encouraged.*

**Canopies and Project Awnings:** Permanent fixed canopies shall be subject to City of Pflugerville approval. Projections within the public right-of-way will require license agreements with the City of Pflugerville. Fabric awnings that provide shade and color are encouraged, particularly high-quality retractable ones that can be adjusted seasonally and throughout the day.

**Trash, Recycling and Compostables Receptacles:** All trash, recyclables and compostables generated by the café shall be disposed of by the business in receptacles provided internal to the building or within the café zone. Any exterior receptacles shall be of durable commercial grade materials and located against the building facade. No such receptacles will be permitted in the curbside zone.

**Storage:** Furniture may not be stacked or stored outside in setback areas or in the public right-of-way at any time. Café furniture shall not be secured to street lighting poles, trees or any other public street furniture.

## 5.10 SERVICES AND UTILITIES

### **Electrical power transformers, switchgear, and equipment:**

Transformers, switchgear enclosures, and other related power service equipment shall generally be located along service drives within or adjacent to parking garages or set back from the street substantially and screened, either with an enclosure or vegetation, as allowed by Oncor. To the maximum extent possible, switchgear enclosures, transformer pads and other equipment shall not be located facing (or visible from) a Pedestrian-Priority street or its building setback areas. Site developers will be required to obtain approval from Oncor and the City of Pflugerville for the appropriate number, sizes and final locations of transformers serving their sites.

**Irrigation Meters:** Irrigation meters shall be located within in-grade vaults and located within planting zones that allow adequate visual, vegetated buffering from public view.

**Reduced Pressure Zone (RPZ) Devices:** RPZs shall be located on the property-owner side of the water meter, i.e., on private property, and shall be encased in an insulated enclosure of fiberglass or stainless steel.

**Backflow Preventers:** Backflow preventers shall be located on the property-owner side of the water meter - on private property - and shall be encased in an insulated, stainless steel “guard shack”.

**Grease Traps:** Grease traps shall be carefully-sited, preferably away from Pedestrian-Priority street frontages or sidewalks, and located in service zones, within buildings, or in setback areas along secondary streets. The surface of the vault shall be below grade to a depth that allows ornamental landscape materials to be planted over the extent of the vault with only the vents appearing at the surface.

**Utility Easement(s):** All utilities, including dry utilities such as gas, communication, and electric, will be contained within the provided right-of-way so that an additional Public Utility Easement is not needed within the development parcels adjacent to all public street frontages.

## 5.11 PUBLIC ART

Public art should be incorporated at key locations within Downtown East in coordination with the City of Pflugerville’s Art in Public Places program. Locations should be selected to enhance significant civic locations, such as in front of City Hall and the Civic Plaza, and at important gateway locations, such as at the Main Street/FM 685 intersection. Community and stakeholder input should play a key part in the selection of the artist and in the review of the proposed work.







# 6

## Open Space Design Guidelines

The landscape approach for Downtown East weaves together the distinct ecosystems of Central Texas where the rolling Central Texas Savannah grasslands may have once given way to Blackland Prairie, dotted with the occasional white limestone outcropping, reminiscent of the Texas Hill Country. Inspired by the presence of the adjacent riparian Greenbelt of the Gilleland Creek system, with its expansive natural bedrock formations, hidden springs and seeps, the design philosophy incorporates these elements into civic spaces situated at the higher elevations nearer to the core of the development. A shared-use trail system winds its way through this diverse landscape, connecting these hubs and fostering a deep connection between its patrons and the surrounding environment.

## 6.1 OPEN SPACE DESIGN PRINCIPLES

Consideration of these principles will create spaces central to the allure of the new civic, mixed-use development, promoting community well-being, environmental sustainability and vibrant placemaking.

### Accessibility and Inclusivity:

- Ensure all open spaces are accessible to everyone, regardless of age, ethnicity, gender, ability or mobility. This includes incorporating features like gently-sloped pathways, universally-accessible pathways, and stable, level surfaces.
- Cater to diverse needs by providing a variety of spaces for different activities, such as quiet contemplation, active play and community gatherings, such as festivals and farmers' markets.
- Encourage social interaction and community-building by providing opportunities for people to congregate and connect naturally.

### Functionality and Usability:

- Create well-defined and functional open spaces that meet the specific needs of the community.
- Ensure open spaces are safe and secure, with adequate lighting, security measures, and clear sight lines at intersections and crosswalks.
- Generally follow CPTED (Crime Prevention through Environmental Design) principles to ensure that people feel safe and secure, and that spaces may be naturally surveilled by open space users.
- Consider implementing CCTV cameras to promote security within public open spaces.
- Consider the ongoing maintenance needs of the space, using durable materials and features that are easy to clean and maintain.





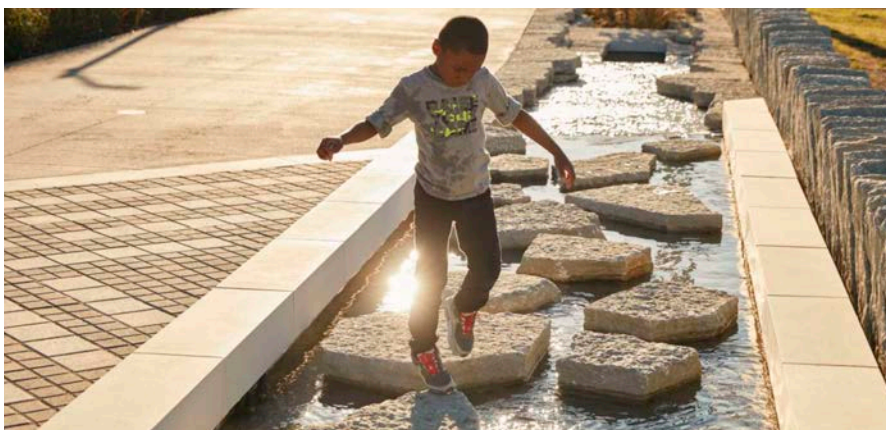
### Integration and Connectivity:

- Seamlessly integrate open spaces with building facades and their surrounding streets to create a cohesive and walkable environment.
- Provide clear and easy access to open spaces from all parts of the development.
- Consider how open spaces shall connect the development to the broader urban fabric through its extensive trail system, and how a wayfinding system may be deployed to make getting around by foot, bike and car as intuitive and enriching as possible.



### Sustainability and Environmental Design:

- Use native, or regionally-adapted, low-maintenance plants, rainwater harvesting, condensate collection and energy-efficient lighting.
- Create microclimates within open spaces to provide shade and cooling during hot weather. Allow adaptation to extend activities into the cooler season.
- Promote biodiversity by incorporating features that attract wildlife in appropriate locations. Celebrate these features through educational and interpretive signage that could be developed by public artists.



### Aesthetics, Placemaking and Public Art:

- Create visually-appealing and inviting open spaces using a variety of design elements like layered and textured landscape plantings, ephemeral water features, public art, and comfortable seating.
- Reflect the unique character and history of the downtown area, incorporating local materials and design elements.
- Create a sense of place and community by providing opportunities for people to gather, interact, and celebrate their shared identity.
- Identify locations for public art that can also tell stories of the history and culture of the community and act as wayfinding landmarks within the landscape.

## 6.2 PARKS AND OPEN SPACE

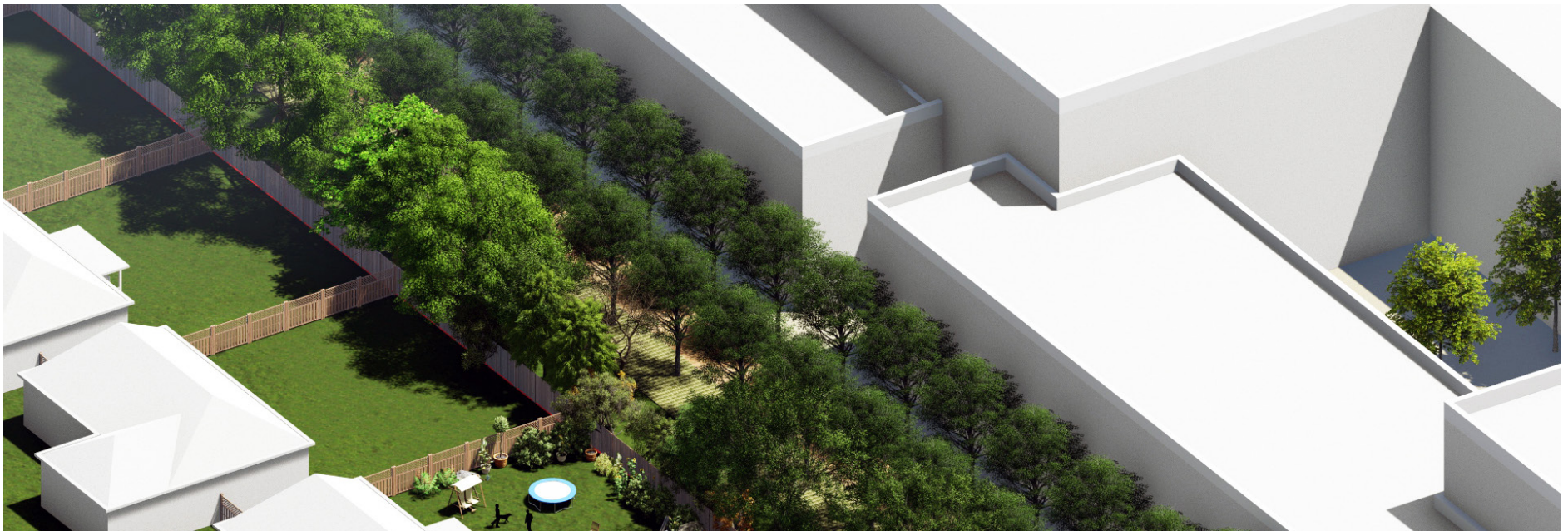
Approximately 9.5 acres of the Downtown East District will be newly dedicated publicly accessible open space. This, along with the 3.5 acres of existing parkland along Gilleland Creek, represents approximately 40% of the entire district and includes the Greenbelt and Trail system and the Civic Plaza. Figure 32 and Exhibit H of the PUD delineates this open space system, including a portion already designated as open space, and the newly dedicated portions that are within and outside of the floodplain.

As set forth in Exhibit H, new residential development will be subject to the City of Pflugerville Parkland Dedication requirements set forth in Chapter 14 of the Unified Development Code (UDC). As shown on Exhibit H, the 9.5 acres of new open space can support a total of 531 dwelling units under the provisions of the UDC. All dwelling units above the total of 531 will be required to provide the required fee, in-lieu of dedication as stipulated in the UDC. In addition, each residential unit will be required to pay the Park Development Fee as set forth in Section 14.4.2 of the UDC. It is recommended that this fee be utilized for on-site amenities and playgrounds.

## 6.3 VEGETATIVE BUFFER YARD AND SCREENING

In addition to its open space and recreational role, the northern and western edges of the Greenbelt will also serve as a Vegetative Buffer Yard providing visual separation and privacy from the adjacent single-family residents. As shown in Figures 13A and 13B, this vegetative buffer yard shall provide a minimum of 68 feet of effective setback from single-family residential properties along Cedar Ridge Drive, and 130 feet from the adjacent residential properties along Meadow Creek Drive. Planting within this quadrant of the Greenbelt will augment the existing vegetation along the fence line of these properties, which shall be maintained.

The following screening requirements shall apply to the landscape treatment of these Greenbelts where they interface with the existing single-family residential neighborhoods. These requirements exceed the buffer yard screening requirements set forth in Subchapter 11.10 of the Unified Development Code, and as such the UDC requirements will not apply.



*The north and west edges of the District shall be planted to provide adequate screening for adjacent homes and to create an inviting open space for people to enjoy.*

1. Along these Greenbelts a minimum of seven (7) evergreen trees shall be planted for every 100 feet of frontage adjacent to a single-family zoned property.
2. These trees shall be planted and irrigated so that after five (5) years they grow to a minimum height of 25 feet.
3. The multi-family developer of the adjacent property shall be responsible for the installation of the landscape screening and irrigation.
4. The developer and/or the Property Owners Association (POA) shall be responsible for the ongoing maintenance of the trees and related irrigation systems.
5. The Administrator shall confirm that the design significantly obstructs sight lines between the planned multi-family development and the back yards of the adjoining single-family homes.
6. Along the northern Greenbelt adjacent to the Cedar Ridge neighborhood, the required trees shall be planted in a double row at intervals of 25 to 30 feet on either side of the planned fire lane.
7. Along the western Greenbelt adjacent to the Meadow Creek neighborhood, the required trees shall be clustered and planted along the planned trail system in a manner that provides shade as well as screening.
8. All efforts will be made to maintain the existing vegetation, and as such no new fence or wall is required.
9. Stormwater detention facilities may be approved by the Administrator if such facilities do not affect existing or required planting as described above.



*Trees planted in the Greenbelt to provide screening for adjacent homes shall be irrigated and maintained so that they reach a mature height of at least 25 feet.*

## 6.4 GREENBELT & TRAIL SYSTEM

Pflugerville is the Trail Capital of Texas. Boasting over 50 miles of trails, 94% of Pflugerville residents can access the trail system within a half mile of their home. The Pflugerville Parks and Recreation Department plans to expand and enhance the trail system to connect residents with recreational facilities throughout the city, and the Downtown East District offers an opportunity to further this goal.

The Downtown East District will allow the city to provide new public facilities, including a new City Hall and Recreation Center, that will be easily accessible via the city trail system. The District is situated adjacent to the Gilleland Creek Trail Corridor, which serves multiple trail routes, including the Gilleland Creek Trail and the Heritage Loop Trail. A “Greenbelt” buffer of open space wraps around the perimeter of the District, providing the opportunity for new parkland and recreational space, and for a new loop of trails around the District for residents and visitors to enjoy. Figure 32 depicts a conceptual alignment of the proposed trail system for the Downtown East District.

### Connections to the Existing Gilleland Creek/Heritage Loop Trails:

Connectivity between the District’s civic spaces and the existing trail system will be provided to enhance the user experience of the natural environment while creating a strong link to the surrounding community. These include:

- **Main Street Bridge Trail Connections:** The initial trail connection between the Gilleland Creek Trail Corridor and the Downtown East District will be provided by the proposed Main Street Bridge across Gilleland Creek. The primary trail connection will be located on the north side of the bridge where a 12’-wide Shared-Use Path is proposed (see Figure 20).
- **Additional Connections Across the Creek:** Additional trail connections between the District and the existing Gilleland Creek Trail Corridor would enhance overall connectivity and provide additional open space opportunities for people to enjoy. These additional connections are shown on Figure 32 in dashed lines. These connections will require additional study for feasibility.

### Internal Trails within the District:

A system of trails internal to the district will enhance connectivity and the recreational experience for both residents and visitors (Figure 32). These include:

- **Primary Trails** within the district will provide direct connections between the district’s central civic spaces, trailhead nodes and key points of interest. Primary trails shall be at least 10’ wide and accessible with a smooth surface suitable for walkers, joggers and cyclists, in accordance with the Pflugerville Trails Master Plan. Within the more naturalized Greenbelt open space, occasional observation decks, platforms or terraces may be strategically placed along the slopes of the trail network to allow users to safely observe the creek, rock outcroppings and surrounding wildlife without disturbing their habitat or other sensitive features. The primary trails of the District form a perimeter loop around the Pfluger Tract with access to the adjacent single-family neighborhood to the north and west provided via the proposed FM 685 shared-use path, or a possible future trail connection to Cedar Ridge Drive through the parcel currently occupied by a car wash.
- **Secondary Trails** are envisioned to complement the primary trail network and provide a more intimate nature experience. Branching from primary trails, secondary trails should be narrower to bring nature closer to the user. To the maximum extent practicable secondary trails should be fully accessible; where grading does not allow for full access, efforts shall be made to provide alternative routes via the primary path system. Surfaces on the secondary trails may be more uneven, with natural materials such as compacted crushed stone, flagstone, or large shredded wood mulch chips. These may be ideal for trail users seeking a closer connection to nature or a longer, more secluded, recreational experience. Smaller observation decks, platforms or terraces may be strategically-placed along the slopes of this trail network to allow users to safely observe natural features in a more intimate environment.

### Legend

-  Existing Trails
-  New Primary Trails
-  Potential Secondary Trails
-  Fire Lane/Trail
-  Greenbelt
-  Civic Plaza



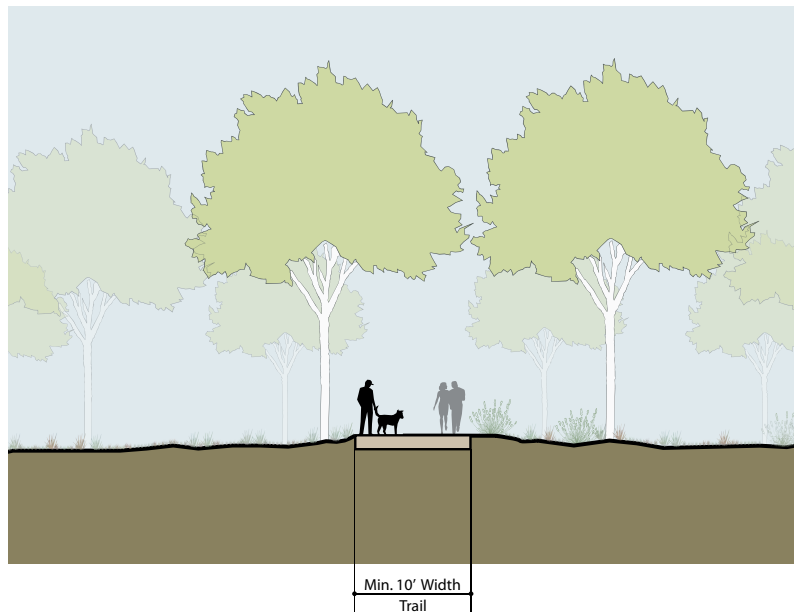
Figure 32: Trail Alignment Diagram

## TRAIL CROSS-SECTIONS

The primary trail system will feature three different cross sections (Figure 33), depending on their context:

### Greenbelt Trail (At-Grade):

The At-Grade Greenbelt Trail's purpose is to provide pedestrian and bike recreation within designated open space of the Downtown East District and along Gilleland Creek. The trail width is to be provided at a 10-ft. minimum. The trail's surface material shall be concrete to match the existing Gilleland Creek trailway. Grading for the at-grade Greenbelt Trail shall avoid root zones of significant trees and large stands of trees in general. Grading at the edges of the constructed trailway shall be blended into the natural environment and be revegetated appropriately with native species acceptable by the City of Pflugerville.



### Fire Lane Trail:

The Fire Lane Trail's purpose is to provide a pedestrian and bikeway thoroughfare connecting Pflugerville's greater trail systems via the Downtown East District's northern and northwestern street grid border. This trail and its surface materials also provide a dual purpose for necessary infrastructure required by the City of Pflugerville for fire emergency access along the northern and western edges of Parcels 6 and 7. The trail's materials consist of a combination of reinforced gravel and reinforced turfgrass to accommodate bikes, pedestrians and fire vehicles. Materials identified for this trail are to utilize low-impact design strategies to reduce impervious cover allowing for surface drainage to occur and overall reduction in stormwater runoff and heat island reduction. The Fire Lane trail section is intended to complement the function of the Greenbelt as a Vegetative Buffer Yard, allowing for dense and diverse landscaping and tree plantings.

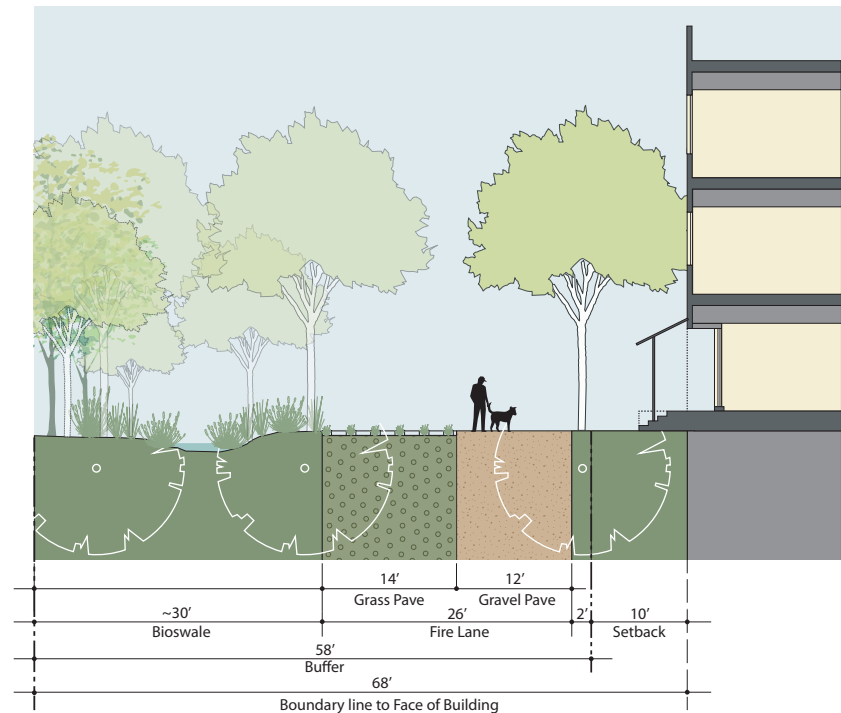
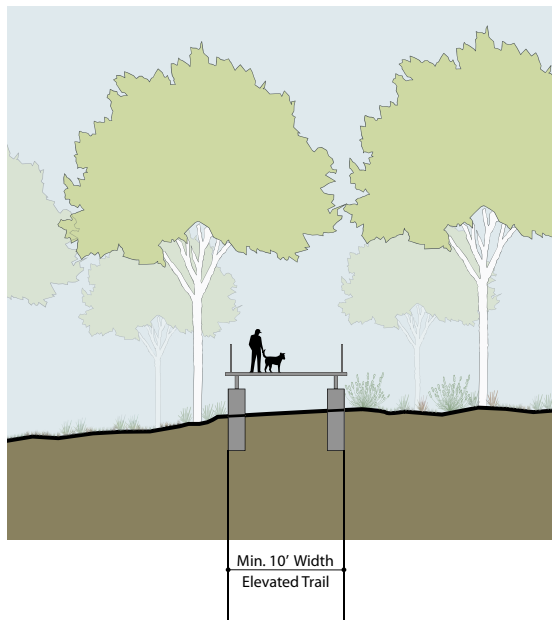


Figure 33: Trail Concept Sections



### Greenbelt Trail (Elevated):

The Elevated Greenbelt Trail's purpose is to provide pedestrian and bike recreation within the designated open space of the Downtown East District and along Gilleland Creek in environmentally sensitive and grade-challenging areas. The trail width is to be provided at a 10-ft. minimum. The trail's surface material is proposed to match existing, concrete trailway infrastructure. The structure of the elevated trail system is suggested to utilize a piered approach to minimize interruption of drainage to Gilleland Creek. The piered system also is intended to minimize grading, provide a strategic means to floodplain avoidance, provide scenic vistas and to reduce the disturbance of existing natural conditions including creek banks and critical root zones of significant trees and large tree stands. The Elevated Greenbelt Trail shall be considered when trail construction occurs up to the



1/4 critical root zone of significant trees. Due to the elevated nature of a trailway system, railings/ guardrails shall be implemented where the City of Pflugerville requires fall protection. In the absence of railings/ guardrails, curbs (at 6-inches in height) shall be provided at the edges of the elevated trail.



*Elevated trails minimize impacts to existing landscape and drainage.  
(Phil Hardberger Park, San Antonio)*

## 6.5 RECOMMENDATIONS TO IMPROVE THE ECOLOGICAL HEALTH OF THE GREENBELT

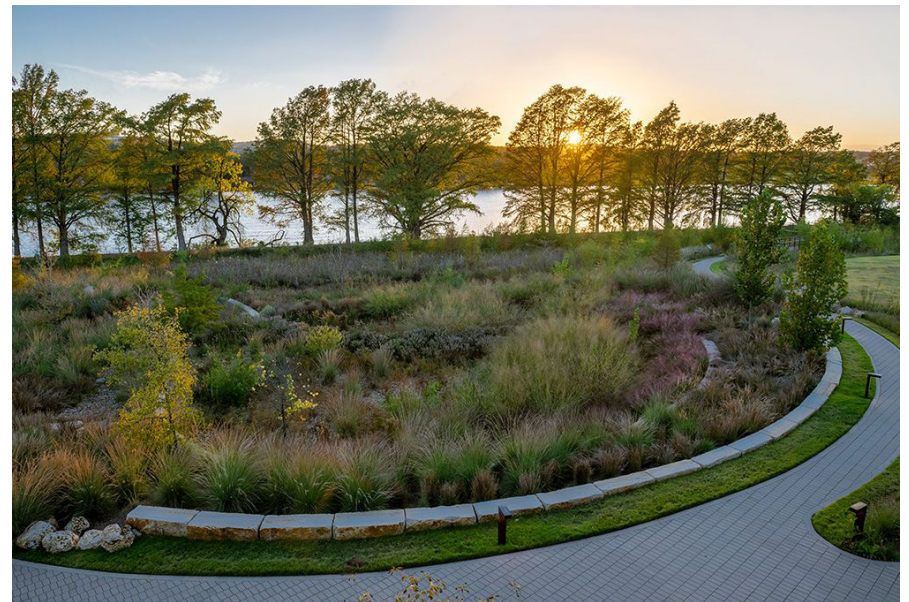
The Downtown East site features many unique environmental features including Gilleland Creek, limestone outcroppings, seeps and other wetland-like elements, and dense foliage. However, due to surrounding development, degradation due to farming, and the arrival of invasive species, the ecological health of these features has been diminished. Key to transforming the Greenbelt area of the District is the restoration of its ecological vitality. Strategies to improve the health of the Greenbelt include removing invasive species, restoring / increasing biodiversity, promoting soil health, reducing erosion, and maximizing water infiltration using current best means and practices.

Additionally, development of the trail system and the Greenbelt as a public open space should employ Low-Impact Development (LID) techniques to minimize negative effects of construction.

LID will minimize environmental impacts while providing access to the site's unique natural systems. Elevated boardwalks may be used for trails along slopes near the Creek, or in the vicinity of springs, seeps and rock outcroppings - instead of concrete slabs-on-grade. This allows increased groundwater infiltration and less concentrated surface stormwater flows, reducing soil erosion. Where on-grade trails are to be used, shallow, landscaped bioswales may be utilized to capture stormwater runoff, filtering it through plants and soil before releasing it slowly, thereby reducing flooding and erosion and promoting a healthy ecosystem.

By combining trail typologies with LID strategies, several goals are achieved:

- **Community connection** - The extended trail system creates a welcoming space for residents, fostering a sense of community and encouraging exploration of the surrounding environment. The creek greenbelt becomes an improved feature along the greater Heritage Loop Trail system.
- **Environmental protection** - LID techniques minimize pollution and protect the delicate ecosystems near the creek and rock outcroppings.
- **Enhanced user experience** - Diverse trail options cater to different preferences, while observation points and gathering nodes provide unique vantage points for appreciating the natural beauty.



## 6.6 CIVIC PLAZA

### Vision:

The Civic Plaza is destined to become Pflugerville’s new heart, welcoming visitors and residents alike, for both day-to-day activities, as well as the weekly farmers’ market and the many special events that the City hosts throughout the year. A generous, 1.2-acre parcel has been set aside at the center of Downtown East, on axis with and to the north of City Hall, immediately west of the new Recreation Center, and immediately east of the pedestrianized D Street and Parcel 5, the highest priority development site in Phase One of the Project.

The Plaza will be centered with the City Hall and its entry features on the south will be placed to reinforce the north-south axis of the City Hall building, which will have a generous, recessed entry plaza giving on to its central lobby and milling area. This glazed space will allow the public to move all the way through the City Hall building, from its front door on Main Street to its “back” door which gives on to Gilleland Creek’s woodland area to the south. The City Hall building will provide connections from this elevated ground floor down to the trail level, so that trail and park users are welcomed from both sides of the building. (See Trail Alignment Diagram above.)

### The Full Build-Out Program:

The City of Pflugerville is interested in establishing the key spaces and structuring framework for the new Civic Plaza, with the following program:

- Stage/Performance Area
- Permanent Food/Retail Building or Kiosk
- Outdoor Gathering
- Shaded Seating
- Events Lawn
- Splash Pad
- Public Art
- Children’s Play
- Permanent Food/Retail Pavilion

This program will be implemented in phases, with the initial phase being built as part of the overall Downtown East Phase One project. Generally, all of the first phase of the Civic Plaza would contain each of the above Full Build-Out elements, but some would be at a reduced scope or scale. For example, there may be a water element that is not a formal, hardscaped splash pad, but instead could be incorporated as a “nature play” element that will attract children and families, as indicated in Figure 34: Civic Plaza Concept Plan.

Of key importance in activating the Plaza is the role of **D Street**, the pedestrian-only promenade, designed to accommodate the Saturday Farmers Market, where typical 10-foot by 10-foot pop-up tents would be installed between each of the street trees. D Street could also accept food carts and trucks, and could host a variety of other temporary furnishings to support other markets and exhibitions.

Main Street and the City Hall itself will be major Plaza activators, so the treatment of the Plaza/park along its southern edge is critical in welcoming the public into this new civic space.





## The Concept Plan:

This Concept Plan illustrates the key program spaces and elements of the park, which are arranged around a slightly sunken **Events Lawn** that defines this area as a special, more protected space, ideal for children’s informal play and any number of performances or special events.

A key design concept for the large open space of the **Lawn** (approximately 100 feet wide in the east-west direction; and 180 feet in the north-south direction) is to assure that its edges are occupiable and shaded. The step-down to the Lawn is created by edges of limestone “ledge stones”, which are naturally flat - top and bottom - stones that were actually quarried from geological ledges in the ground. They are generally from 12” to 24” high, making them a good height for a seat wall, which could be fairly continuous along the east and west sides of the Lawn. This creates an irregular, naturalistic and informal feel to the Plaza, and extends the sense of the Hill Country landscape into the Plaza. The Lawn’s irregular shape and its slightly-sloping surface are meant to dissuade its use for larger sports, like pick-up soccer games. Three or more large shade trees are planted strategically to frame the Lawn and provide an immediate shade and visual pop, again recalling the Central Texas Savannah or woodland landscape that is native to the Gilleland Creek corridor. The Lawn will be of artificial, pervious turf, so that it is both dog-friendly and crowd-tolerant. Its protruding ledgerrock seat-walls extend the space from D Street and the Recreation Center, giving these two areas room to flow into the new park, which is conceived to be the central space of the Downtown East District - the new heart of the city itself.

The **Stage** is located at the northwest corner of the site, backed by a curved wall to reflect sound towards the south-southeast, well away from the nearby single-family neighborhood to the north and east. In the first phase, the Stage could be as modest as an elevated wood deck of seat-wall height. Special events would bring in their own stage, scaffolding, lighting and sound systems. When not supporting events, the Stage could be used for Farmers’ Market tastings, cooking demonstrations and related casual dining, as well as a place for children’s play, small games, smaller, non-amplified performances, etc.

At the northern edge of the park, a small **Storage** and equipment building is attached to the curved wall Stage backdrop, and would allow for

Figure 34: Civic Plaza Concept Plan

some storage of furnishings, maintenance items, stacking litter bins, and a location for electrical panels, first aid, and small, miscellaneous items and space to support events.

Moving toward the south end of the sloping, sunken Lawn and in proximity to the Recreation Center, is a **Nature Play** area that will include modest water play features.

Immediately south of this area is a shaded **Trailhead**, equipped with benches, and outdoor fitness equipment, such as pull-up bars, a rubber mat surface for stretching and sit-ups, etc. Although not a part of the original program, the Trailhead, with its proximity to food vendors and retailers and the Recreation Center, will make an ideal meet-up place for friends or groups who want to “hit the trail” for walking, jogging, biking or rolling on the Heritage Loop Trail and beyond. A major wayfinding point could be established here, for orientation to the trail system, as well as to the Downtown East district and the many other civic and recreational facilities nearby.

Typically, a trailhead would be located adjacent to a public restroom, which would also provide drinking fountains and bike parking. It is assumed that drinking fountains with a bottle filler will be located near the main entry to the Recreation Center, so these would not be duplicated within the Plaza itself. It is also assumed that a public restroom serving



*Nature Play areas can double as drainage infrastructure*

the Plaza’s day-to-day users would be built as part of the Recreation Center, and that it will be accessible from the exterior of this building, so park patrons could enter it directly, without needing to access the Recreation Center lobby. Bike parking will be provided near the Trailhead, either in conjunction with bike racks related to the Recreation Center, or in addition to these, which should be highly visible from Main Street.

Provision for food trucks is made along the north curblin of Main Street, where the tree line along the street is interrupted by a weatherproof **Civic Canopy** that offers a shaded, dining and game space and a promenade zone connecting the south edge of the Recreation Center and future parking on Parcel 5. The Canopy is discontinuous at the center of the Plaza, which is also the center of the City Hall building, in order to preserve sightlines and a strong sense of connection between the two facilities.

Extending from this central axis, is a lightweight, vine-covered trellis or **Arbor** that brings park patrons into the Lawn area. This arbor helps connect criss-crossing pathways between D Street, the Trailhead, the Recreation Center and Parcel 5, while providing benches, a place to read or meet friends and a place for parents to keep an eye on children in the Nature Play area.



*An example of a plaza with space for large seasonal decorations (Alpharetta, Georgia)*

Appendix A:

# Pflugerville Civic Center Preliminary Parking Needs Analysis Summary

Prepared by Walker Consultants



Date: May 16, 2024  
To: Korin Crawford  
Company: Griffin-Swinerton  
Copy To:  
From: Jeff Weckstein  
Project Name: Pflugerville Civic Center – Preliminary Parking Needs Analysis Summary (Update)  
Project Number: 25-003049.00

## Background

The Pflugerville Civic Center project (the “Project”) in Pflugerville, TX, includes construction of a new City Hall building, Recreation Center, Civic Plaza, restaurant/retail, and, in a subsequent phase, development of several multi-family and mixed-use parcels on a greenfield site. Walker has been re-engaged to provide continued parking planning support, including analysis of the currently envisioned Phase 1 uses and three buildout land use scenarios. This memorandum details the results of the study.

## Preliminary Land Use Program

The Phase 1 and buildout scenarios building programs are summarized below in Table 1. The project team should review the information in the table and provide any updates as applicable.

**Table 1: Pflugerville Town Center Preliminary Land Use Program/Scenarios**

Parcel	Land Use	Phase 1	Buildout Scenario 1	Buildout Scenario 2	Buildout Scenario 3
1	Hotel Restaurant Retail Office		130 Keys 6,000 sqft	2,500 sqft 2,500 sqft 60,000 sqft	7,500 sqft 7,500 sqft
2	City Hall City Hall Café General Office	50,952 sqft <sup>1</sup> 1,250 sqft 14,000 sqft	89,750 sqft 1,250 sqft 14,000 sqft	89,750 sqft 1,250 sqft 14,000 sqft	89,750 sqft 1,250 sqft 14,000 sqft
3	Retail Restaurant Hotel Office		10,000 sqft	5,000 sqft 5,000 sqft 15,000 sqft	5,000 sqft 120 Keys
4	Recreation Center Restaurant Retail	128,210 sqft 7,500 sqft 3,000 sqft	128,210 sqft 7,500 sqft 3,000 sqft	128,210 sqft 7,500 sqft 3,000 sqft	128,210 sqft 7,500 sqft 3,000 sqft
5	Civic Plaza Restaurant Retail Cinema Multifamily	250 people	250 people 15,000 sqft 15,000 sqft	250 people 10,000 sqft 10,000 sqft 600 seats	250 people 10,000 sqft 10,000 sqft 220 du
6	Multifamily Office		140 du	350 du	200 du 100,000 sqft
7	Multifamily		134 du	315 du	315 du

Notes: sqft = square feet, du = dwelling units

1 = Physically City Hall is planned at 89,750 square feet; however, in Phase 1 a lower square footage was analyzed to align with current staff levels

Multifamily unit mix assumed 10% studio, 50% 1-bedroom, 40% 2-bedroom

250 represents estimated design day event attendance at civic plaza

## Preliminary Parking Needs Analysis

Walker created a shared parking model based on the Urban Land Institute (ULI)/National Parking Association (NPA) shared parking model and Shared Parking publication for the proposed Project. Shared parking is an industry-accepted practice, and the Shared Parking publication is the current standard of analysis accepted by municipalities and even adopted into Municipal Codes throughout the country.

The following assumptions underpin the preliminary parking needs analysis for the project.

- Land use quantities as shown in Table 1.
- The recreation center was analyzed using the information in *Shared Parking* for the Library land use as a base, with time-of-day factors updated to reflect projected uses of the Center.
- The Civic Plaza was analyzed as a 250-seat amphitheater to simulate a 250-attendee design day event.
- For Phase 1, the service employee drive ratio is 88%, and the office employee drive ratio is 93% based on available US Census Means of Transportation to Work data for Pflugerville.



- For Buildout scenarios, the service employee drive ratio is 80%, and the office employee drive ratio is 92% based on available US Census Means of Transportation to Work data for Pflugerville and anticipated increases in transit connectivity for the site in the buildout conditions.
- A customer/visitor drive ratio of 99% for Phase 1 conditions and 97% for buildout scenarios.
- City Hall employee parking is signed as reserved for City Hall employees from 6:00 a.m. to 5:00 p.m. on weekdays but assumed to be shareable at night and on weekends.
- Fifty (50) parking spaces reserved 24/7 for City Fleet vehicles
- Two hundred (200) spaces are reserved for a future park-and-ride from 6:00 a.m. to 5:00 p.m. on weekdays, but they are assumed to be shareable at night and on weekends (buildout scenarios only).
- Resident parking is assumed to be reserved and segregated, but residential guest parking is considered part of the site's shared parking pool.

## Parking Needs Analysis Results – Phase 1

Table 2 summarizes the results of the Phase 1 parking needs analysis for weekdays.

**Table 2: Pflugerville Town Center Phase 1 – Projected Peak Weekday Parking Demand**

Land Use	Project Data		Weekday					Weekday		
			Base Ratio	Driving Adj	Non-Captive Ratio	Project Ratio	Unit For Ratio	Peak Hr Adj	Peak Mo Adj	Estimated Parking Demand
	2 PM	October								
Retail (<400 ksf)	3,000	sf GLA	2.90	99%	87%	2.49	ksf GLA	95%	69%	5
Employee			0.70	88%	100%	0.62		100%	78%	2
Fast Casual/Fast Food	8,750	sf GLA	12.40	99%	74%	9.06	ksf GLA	90%	96%	69
Employee			2.00	88%	100%	1.76		95%	100%	15
Outdoor Amphitheater	250	seats	0.30	100%	77%	0.23	seat	1%	50%	-
Employee			0.07	88%	100%	0.06		30%	60%	3
Rec Center	128,210	sf GLA	2.00	100%	87%	1.73	ksf GLA	60%	100%	134
Employee			0.25	88%	100%	0.22		75%	100%	22
Convention Center		sf GLA	5.50	100%	100%	5.50	ksf GLA	100%	85%	-
Employee			0.50	88%	100%	0.44		100%	95%	-
Office <25 ksf	14,000	sf GFA	0.30	99%	100%	0.30	ksf GFA	95%	100%	5
Reserved		empl	0.00	93%	100%	0.00		100%	100%	-
Employee			3.50	93%	100%	3.26		95%	100%	43
Government Office	50,952	sf GFA	1.19	99%	100%	1.18	ksf GFA	95%	100%	57
Reserved	1	emp	2.70	93%	100%	2.51		100%	100%	128
Customer/Visitor										270
Employee										85
CH Fleet Vehicles										50
<u>Reserved CH Emp 6A-5P</u>										<u>128</u>
Total										533

As shown in Table 2 The projected peak weekday parking demand for Phase 1 is 533 parking spaces, projected to occur at 2:00 p.m.

Figure 1, on the next page, shows the projected accumulation of parking demand over the weekday for Phase 1 of the project.

Figure 1: Pflugerville Phase 1 Weekday Parking Demand by Hour

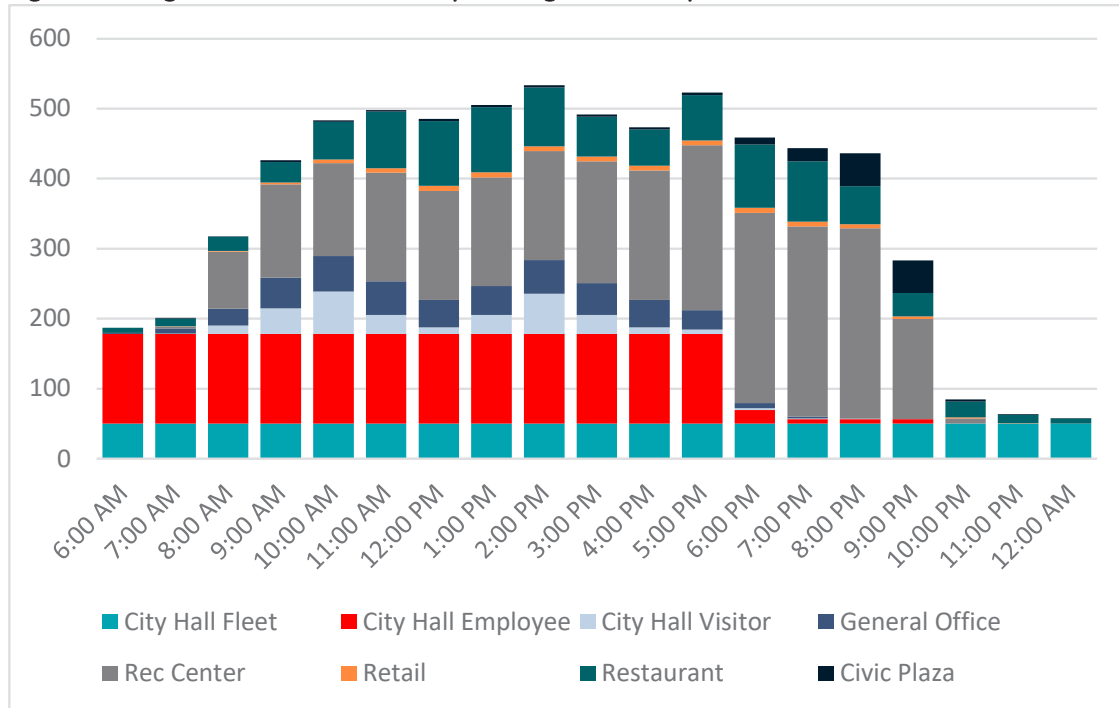


Table 3 summarizes the results of the Phase 1 parking needs analysis for weekends.

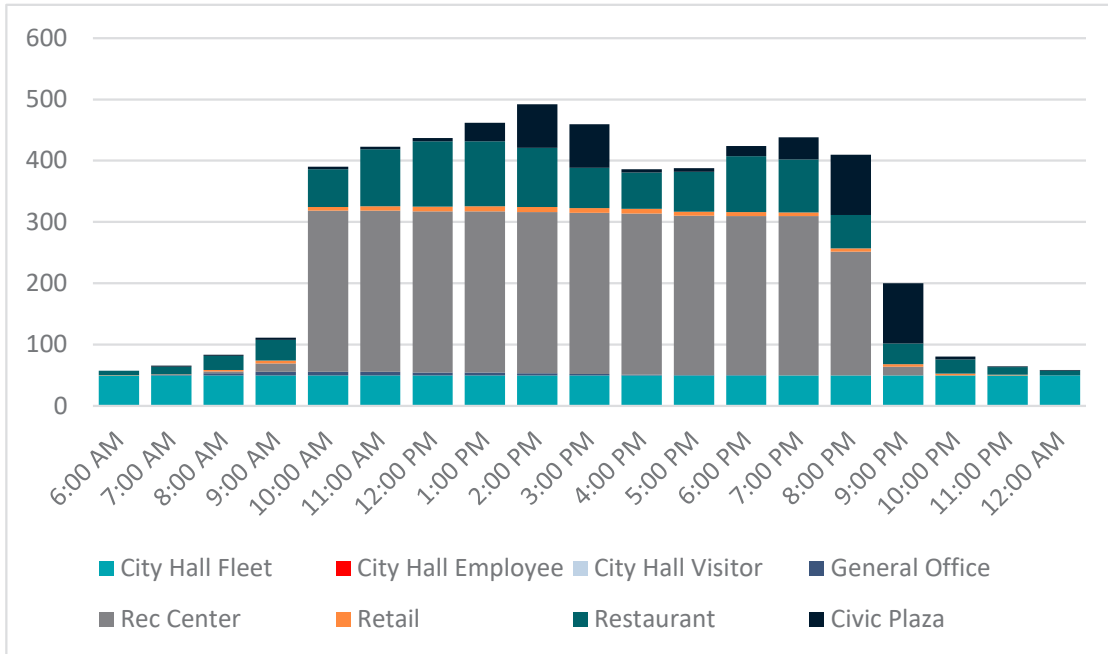
Table 3: Pflugerville Town Center Phase 1 – Projected Peak Weekend Parking Demand

Land Use	Project Data		Weekend					Weekend			
			Base Ratio	Driving Adj	Non-Captive Ratio	Project Ratio	Unit For Ratio	Peak Hr Adj	Peak Mo Adj	Estimated Parking Demand	
	2 PM	September									
Retail (<400 ksf)	3,000	sf GLA	3.20	99%	96%	3.05	ksf GLA	100%	66%	6	
Employee			0.80	88%	100%	0.70		100%	76%	2	
Fast Casual/Fast Food	8,750	sf GLA	12.70	99%	88%	11.07	ksf GLA	90%	93%	81	
Employee			2.00	88%	100%	1.76		95%	100%	15	
Outdoor Amphitheater	250	seats	0.33	100%	100%	0.33	seat	67%	100%	55	
Employee			0.07	88%	100%	0.06		100%	100%	16	
Rec Center	128,210	sf GLA	2.00	100%	96%	1.93	ksf GLA	100%	95%	235	
Employee			0.25	88%	100%	0.22		100%	95%	28	
Office <25 ksf	14,000	sf GFA	0.03	99%	100%	0.03	ksf GFA	50%	100%	-	
Reserved		empl	0.00	93%	100%	0.00		100%	100%	-	
Employee			0.35	93%	100%	0.33		60%	100%	3	
Government Office	50,952	sf GFA	0.00	99%	100%	0.00	ksf GFA	50%	100%	-	
Reserved	1	emp	0.00	93%	100%	0.00		100%	100%	-	
										Customer/Visitor	377
										Employee	64
										CH Fleet Vehicles	50
										Reserved	-
										Total	491

As shown in Table 3, projected peak weekend parking demand for Phase 1 is 491 parking spaces, which is projected to occur at 2:00 p.m.

Figure 2 shows the projected accumulation of parking demand over the day on the weekend for Phase 1.

**Figure 2: Pflugerville Phase 1 Weekend Parking Demand by Hour**



## Parking Needs Analysis Results – Buildout Scenario 1

Table 4 summarizes the results of the Buildout Scenario 1 parking needs analysis for weekdays.

**Table 4: Pflugerville Town Center Buildout Scenario 1 – Projected Peak Weekday Parking Demand**

Land Use	Project Data		Weekday					Weekday		
			Base Ratio	Driving Adj	Non-Captive Ratio	Project Ratio	Unit For Ratio	Peak Hr Adj	Peak Mo Adj	Estimated Parking Demand
	Quantity	Unit						1 PM	March	
Retail	18,000	sf GLA	2.90	97%	91%	2.57	ksf GLA	100%	70%	33
Employee			0.70	80%	99%	0.56		100%	79%	8
Fine/Casual Dining	5,000	sf GLA	13.25	97%	77%	9.87	ksf GLA	75%	98%	37
Employee			2.25	80%	99%	1.79		90%	100%	9
Family Restaurant	5,000	sf GLA	15.25	97%	77%	11.36	ksf GLA	90%	98%	51
Employee			2.15	80%	99%	1.71		100%	100%	9
Fast Casual/Fast Food	23,750	sf GLA	12.40	97%	74%	8.89	ksf GLA	100%	97%	204
Employee			2.00	80%	99%	1.59		100%	100%	38
Outdoor Amphitheater	250	seats	0.30	100%	10%	0.03	seat	1%	0%	-
Employee			0.07	80%	99%	0.06		30%	10%	-
Rec Center	128,210	sf GLA	2.00	100%	91%	1.83	ksf GLA	60%	100%	141
Employee			0.25	80%	99%	0.20		75%	100%	20
Hotel	130	keys	1.00	59%	100%	0.59	key	55%	90%	38
Hotel Employees	130	keys	0.15	80%	99%	0.12	key	100%	90%	14
Restaurant/Lounge	6,000	sf GLA	6.67	63%	90%	3.78	ksf GLA	100%	95%	22
Restaurant/Meeting Employees	6,000	sf GLA	1.20	80%	99%	0.95	ksf GLA	100%	100%	6
Residential										
Studio Efficiency	27	units	0.00	100%	100%	0.00	unit	50%	100%	-
1 Bedroom	137	units	0.00	100%	100%	0.00	unit	50%	100%	-
2 Bedrooms	110	units	0.00	100%	100%	0.00	unit	50%	100%	-
Reserved	100%	res spaces	1.20	100%	100%	1.20	unit	100%	100%	328
Visitor	274	units	0.10	97%	100%	0.10	unit	20%	100%	5
Office <25 ksf	14,000	sf GFA	0.30	97%	100%	0.29	ksf GFA	45%	100%	2
Employee			3.50	92%	96%	3.10		85%	100%	37
Government Office	89,750	sf GFA	1.19	97%	100%	1.15	ksf GFA	45%	100%	47
Reserved	1	emp	2.70	92%	100%	2.48		100%	100%	224
								Customer/Visitor		580
								Employee		141
								CH Fleet Vehicles		50
								Reserved CH Emp 6A-5P		224
								<u>Reserved Resident</u>		<u>328</u>
								<b>SubTotal</b>		<b>1,323</b>
								Park & Ride 6A-5P		200
								<i>Total with P&amp;R</i>		<i>1,523</i>

As shown in Table 4, the projected peak weekday parking demand for Buildout Scenario 1 is 1,523 spaces, projected to occur at 1:00 p.m., including 200 spaces for a potential park-and-ride. Absent the park-and-ride, the projected peak weekday parking demand for Buildout Scenario 1 is 1,323 spaces.

Figure 3, on the next page, shows the projected accumulation of parking demand over the day on weekdays for Buildout Scenario 1.

**Figure 3: Pflugerville Buildout Scenario 1 Weekday Parking Demand by Hour**

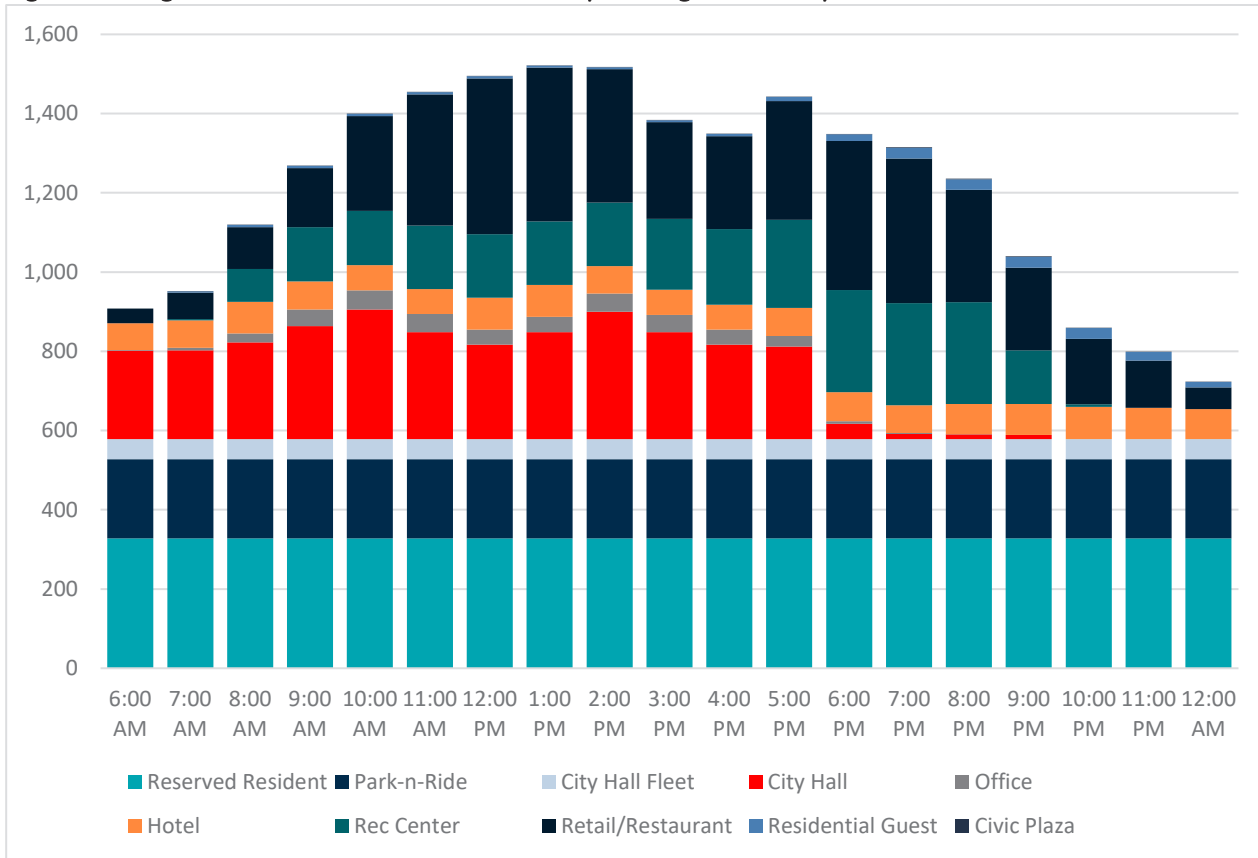


Table 5 summarizes the results of the Buildout Scenario 1 parking needs analysis for weekends.

**Table 5: Pflugerville Town Center Buildout Scenario 1 – Projected Peak Weekend Parking Demand**

Land Use	Project Data		Weekend					Weekend		
			Base Ratio	Driving Adj	Non-Captive Ratio	Project Ratio	Unit For Ratio	Peak Hr Adj	Peak Mo Adj	Estimated Parking Demand
	Quantity	Unit						12 PM	October	
Retail Employee	18,000	sf GLA	3.20	97%	94%	2.92	ksf GLA	95%	69%	36
			0.80	80%	99%	0.63		100%	78%	9
Fine/Casual Dining Employee	5,000	sf GLA	15.25	97%	82%	12.10	ksf GLA	50%	93%	31
			2.50	80%	99%	1.98		75%	100%	8
Family Restaurant Employee	5,000	sf GLA	15.00	97%	82%	11.91	ksf GLA	100%	93%	47
			2.10	80%	99%	1.67		100%	100%	9
Fast Casual/Fast Food Employee	23,750	sf GLA	12.70	97%	82%	10.08	ksf GLA	100%	96%	231
			2.00	80%	99%	1.59		100%	100%	38
Outdoor Amphitheater Employee	250	seats	0.33	100%	83%	0.27	seat	1%	50%	6
			0.07	80%	99%	0.06		30%	60%	9
Rec Center Employee	128,210	sf GLA	2.00	100%	94%	1.88	ksf GLA	100%	100%	241
			0.25	80%	99%	0.20		100%	100%	26
Hotel	130	keys	1.00	69%	100%	0.69	key	55%	95%	47
Hotel Employees	130	keys	0.15	80%	99%	0.12	key	100%	95%	15
Restaurant/Lounge	6,000	sf GLA	7.67	54%	30%	1.24	ksf GLA	100%	96%	7
Restaurant/Meeting Employees	6,000	sf GLA	1.33	80%	99%	1.05	ksf GLA	100%	100%	6
Residential										
Studio Efficiency	27	units	0.00	100%	100%	0.00	unit	68%	100%	-
1 Bedroom	137	units	0.00	100%	100%	0.00	unit	68%	100%	-
2 Bedrooms	110	units	0.00	100%	100%	0.00	unit	68%	100%	-
Reserved	100%	res spaces	1.20	100%	100%	1.20	unit	100%	100%	328
Visitor	274	units	0.15	97%	100%	0.15	unit	20%	100%	8
Office <25 ksf Employee	14,000	sf GFA	0.03	97%	100%	0.03	ksf GFA	20%	100%	1
			0.35	92%	96%	0.31		90%	100%	4
Government Office	89,750	sf GFA	0.00	97%	100%	0.00	ksf GFA	20%	100%	-
Reserved	1	emp	0.00	92%	100%	0.00		100%	100%	-
								Customer/Visitor		655
								Employee		124
								CH Fleet Vehicles		50
								Reserved CH Emp 6A-5P		-
								Reserved Resident		328
								<b>SubTotal</b>		<b>1,157</b>
								Park & Ride 6A-5P		20
								<i>Total with P&amp;R</i>		<i>1,177</i>

As shown in Table 5, the projected peak weekend parking demand for Buildout Scenario 1 is 1,177 parking spaces, projected to occur at 12:00 p.m., including 20 spaces for a potential park-and-ride. Absent the park-and-ride, the projected peak weekend parking demand for Buildout Scenario 1 is 1,157 spaces.

Figure 4 shows the projected accumulation of parking demand over the day on the weekend for Buildout Scenario 1.

Figure 4: Pflugerville Buildout Scenario 1 Weekend Parking Demand by Hour

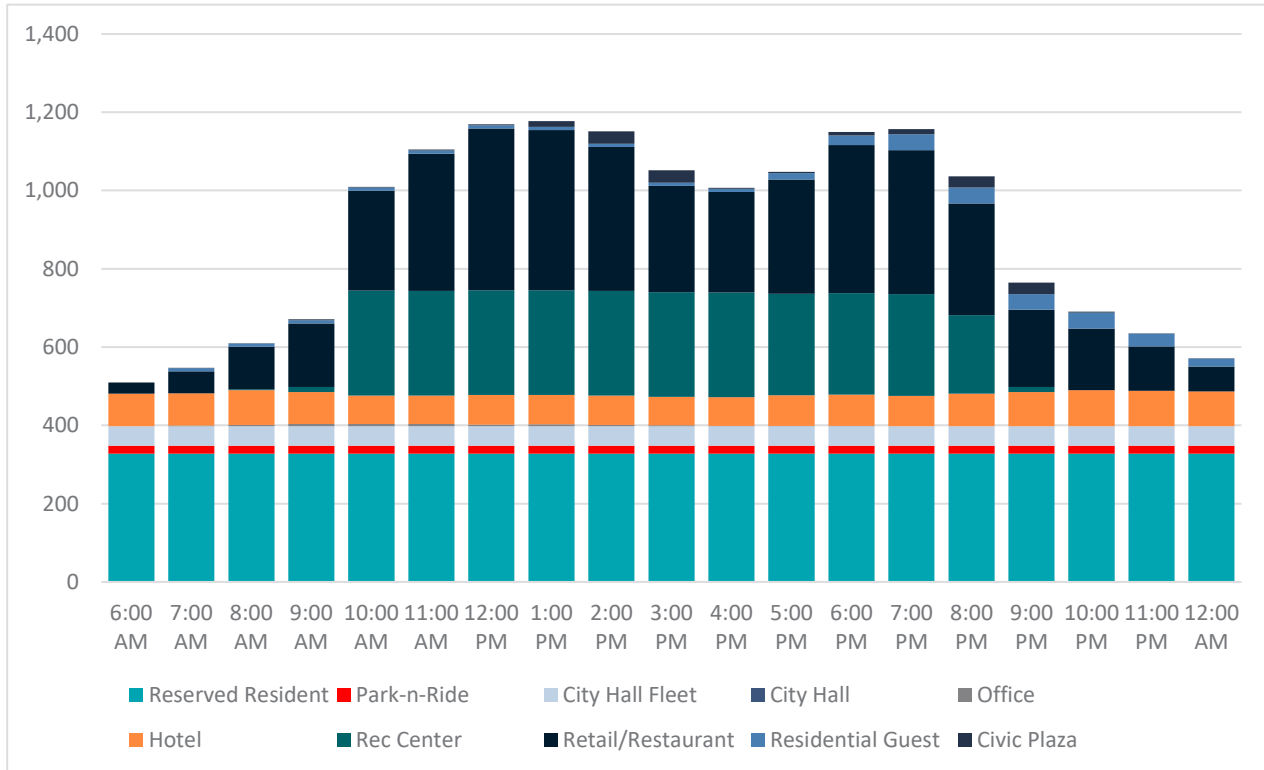


Table 6 summarizes Buildout Scenario 1 parking needs at peak, by parcel.

Table 6: Pflugerville Town Center Buildout Scenario 1 – Distribution of Peak Demand by Parcel

Weekday		Phase 1 (P2/P4)	Parcel 1	Parcel 3	Parcel 5	Parcel 6	Parcel 7	P&R	Total
Parking Demand	Customer/Visitor	271	60	80	163	3	3	200	780
	Employee/Resident	72	20	17	32	0	0	0	141
	Reserved	274	0	0	0	168	160	0	602
	<b>Total</b>	<b>617</b>	<b>80</b>	<b>97</b>	<b>195</b>	<b>171</b>	<b>163</b>	<b>200</b>	<b>1523</b>

Weekend		Phase 1 (P2/P4)	Parcel 1	Parcel 3	Parcel 5	Parcel 6	Parcel 7	P&R	Total
Parking Demand	Customer/Visitor	339	54	80	174	4	4	20	675
	Employee/Resident	54	21	16	33	0	0	0	124
	Reserved	50	0	0	0	168	160	0	378
	<b>Total</b>	<b>443</b>	<b>75</b>	<b>96</b>	<b>207</b>	<b>172</b>	<b>164</b>	<b>20</b>	<b>1177</b>

Note: P&R = Park-and-Ride

## Parking Needs Analysis Results – Buildout Scenario 2

Table 7 summarizes the results of the Buildout Scenario 2 parking needs analysis for weekdays.

**Table 7: Pflugerville Town Center Buildout Scenario 2 – Projected Peak Weekday Parking Demand**

Land Use	Project Data		Weekday					Weekday		
			Base Ratio	Driving Adj	Non-Captive Ratio	Project Ratio	Unit For Ratio	Peak Hr Adj	Peak Mo Adj	Estimated Parking Demand
	Quantity	Unit						2 PM	March	
Retail	18,000	sf GLA	2.90	97%	87%	2.45	ksf GLA	95%	70%	30
Employee			0.70	80%	98%	0.55		100%	79%	8
Fine/Casual Dining	10,000	sf GLA	13.25	97%	75%	9.64	ksf GLA	65%	98%	62
Employee			2.25	80%	98%	1.76		90%	100%	16
Fast Casual/Fast Food	18,750	sf GLA	12.40	97%	54%	6.50	ksf GLA	90%	97%	106
Employee			2.00	80%	98%	1.56		95%	100%	28
Specialty Movie Theatre	600	seats	0.18	100%	87%	0.16	seat	55%	45%	23
Employee			0.02	80%	98%	0.02		60%	55%	3
Outdoor Amphitheater	250	seats	0.30	100%	87%	0.26	seat	1%	0%	-
Employee			0.07	80%	98%	0.05		30%	10%	-
Rec Center	128,210	sf GLA	2.00	100%	87%	1.74	ksf GLA	60%	100%	134
Employee			0.25	80%	98%	0.20		75%	100%	19
Residential										
Studio Efficiency	67	units	0.00	100%	100%	0.00	unit	50%	100%	-
1 Bedroom	333	units	0.00	100%	100%	0.00	unit	50%	100%	-
2 Bedrooms	265	units	0.00	100%	100%	0.00	unit	50%	100%	-
Reserved	100%	res spaces	1.19	100%	100%	1.19	unit	100%	100%	794
Visitor	665	units	0.10	97%	100%	0.10	unit	20%	100%	13
Office <25 ksf	29,000	sf GFA	0.30	97%	100%	0.29	ksf GFA	95%	100%	8
Employee			3.50	92%	95%	3.06		95%	100%	85
Office 25 to 100 ksf	60,000	sf GFA	0.28	97%	100%	0.27	ksf GFA	95%	100%	16
Employee			3.34	92%	95%	2.92		95%	100%	167
Government Office	89,750	sf GFA	1.19	97%	100%	1.15	ksf GFA	95%	100%	99
Reserved	1	emp	2.70	92%	100%	2.48		100%	100%	224
								Customer/Visitor		491
								Employee		326
								CH Fleet Vehicles		50
								Reserved CH Emp 6A-5P		224
								Reserved Resident		794
								<b>SubTotal</b>		<b>1,885</b>
								Park & Ride 6A-5P		200
								<i>Total with P&amp;R</i>		<i>2,085</i>

As shown in Table 7, the projected peak weekday parking demand for Buildout Scenario 2 is 2,085 spaces, and it is projected to occur at 2:00 p.m., including 200 spaces for a potential park-and-ride. Absent the park-and-ride, the projected peak weekday parking demand for Buildout Scenario 2 is 1,885 spaces.

Figure 5, on the next page, shows the projected accumulation of parking demand over the day on weekdays for Buildout Scenario 2.



**Figure 5: Pflugerville Buildout Scenario 2 Weekday Parking Demand by Hour**

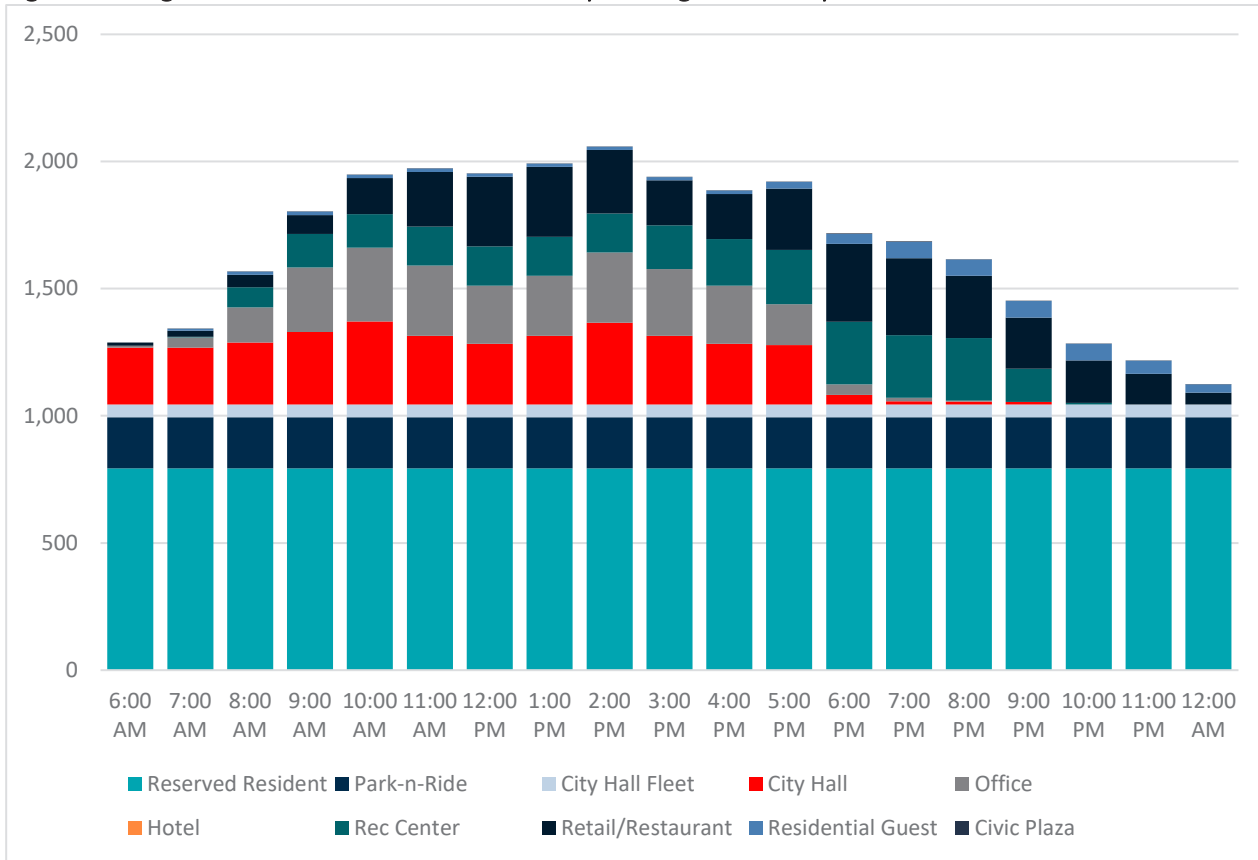


Table 8 summarizes the results of the Buildout Scenario 2 parking needs analysis for weekends.

**Table 8: Pflugerville Town Center Buildout Scenario 2 – Projected Peak Weekend Parking Demand**

Land Use	Project Data		Weekend					Weekend		
			Base Ratio	Driving Adj	Non-Captive Ratio	Project Ratio	Unit For Ratio	Peak Hr Adj	Peak Mo Adj	Estimated Parking Demand
	Quantity	Unit						7 PM	May	
Retail Employee	18,000	sf GLA	3.20	97%	88%	2.73	ksf GLA	70%	72%	25
			0.80	80%	98%	0.63		80%	82%	8
Fine/Casual Dining Employee	10,000	sf GLA	15.25	97%	91%	13.52	ksf GLA	95%	99%	127
			2.50	80%	98%	1.96		100%	100%	20
Fast Casual/Fast Food Employee	18,750	sf GLA	12.70	97%	73%	9.03	ksf GLA	80%	99%	135
			2.00	80%	98%	1.56		90%	100%	27
Specialty Movie Theatre Employee	600	seats	0.29	100%	94%	0.27	seat	80%	70%	92
			0.01	80%	98%	0.01		100%	80%	4
Outdoor Amphitheater Employee	250	seats	0.33	100%	94%	0.31	seat	25%	100%	20
			0.07	80%	98%	0.05		100%	100%	14
Rec Center Employee	128,210	sf GLA	2.00	100%	88%	1.76	ksf GLA	100%	90%	203
			0.25	80%	98%	0.20		100%	90%	23
Residential Studio Efficiency	67	units	0.00	100%	100%	0.00	unit	55%	100%	-
1 Bedroom	333	units	0.00	100%	100%	0.00	unit	55%	100%	-
2 Bedrooms	265	units	0.00	100%	100%	0.00	unit	55%	100%	-
Reserved	100%	res spaces	1.19	100%	100%	1.19	unit	100%	100%	794
Visitor	665	units	0.15	97%	100%	0.15	unit	100%	100%	97
Office <25 ksf Employee	29,000	sf GFA	0.03	97%	100%	0.03	ksf GFA	0%	100%	-
			0.35	92%	95%	0.31		0%	100%	-
Office 25 to 100 ksf Employee	60,000	sf GFA	0.03	97%	100%	0.03	ksf GFA	0%	100%	-
			0.33	92%	95%	0.29		0%	100%	-
Government Office Reserved	89,750	sf GFA	0.00	97%	100%	0.00	ksf GFA	0%	100%	-
	1	emp	0.00	92%	100%	0.00		0%	100%	-
								Customer/Visitor		699
								Employee		96
								CH Fleet Vehicles		50
								Reserved CH Emp 6A-5P		-
								<u>Reserved Resident</u>		<u>794</u>
								<b>SubTotal</b>		<b>1,639</b>
								Park & Ride 6A-5P		20
								<i>Total with P&amp;R</i>		<i>1,659</i>

As shown in Table 8, the projected peak weekend parking demand for Buildout Scenario 2 is 1,659 parking spaces, and it is projected to occur at 7:00 p.m., including 20 spaces for a potential park-and-ride. Absent the park-and-ride, the projected peak weekend parking demand for Buildout Scenario 2 is 1,639 spaces.

Figure 6 shows the projected accumulation of parking demand over the day on the weekend for Buildout Scenario 2.

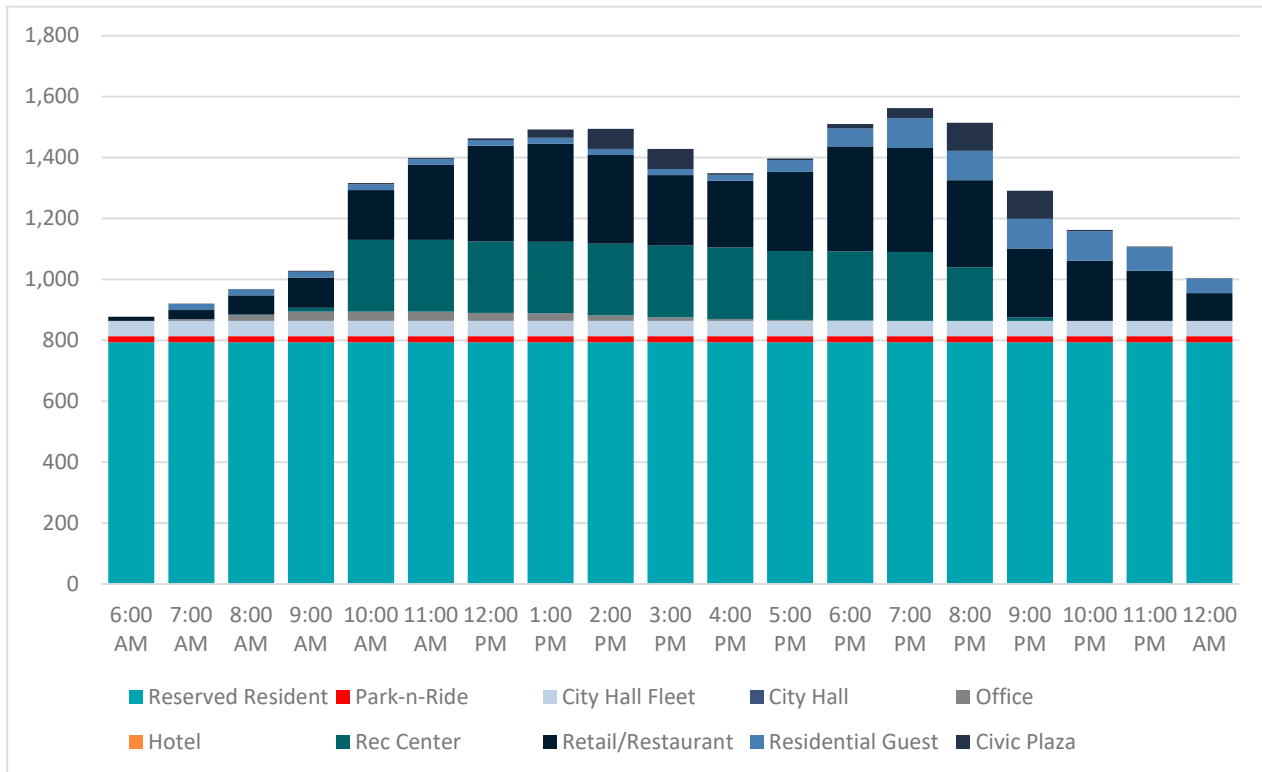
**Figure 6: Pflugerville Buildout Scenario 2 Weekend Parking Demand by Hour**


Table 9 summarizes Buildout Scenario 2 parking needs at peak by parcel.

**Table 9: Pflugerville Town Center Buildout Scenario 2 – Distribution of Peak Demand by Parcel**

Weekday		Phase 1 (P2/P4)	Parcel 1	Parcel 3	Parcel 5	Parcel 6	Parcel 7	P&R	Total
Parking Demand	Customer/Visitor	293	34	53	98	7	6	200	691
	Employee/Resident	74	172	57	23	0	0	0	326
	Reserved	274	0	0	0	418	376	0	1068
	<b>Total</b>	<b>641</b>	<b>206</b>	<b>110</b>	<b>121</b>	<b>425</b>	<b>382</b>	<b>200</b>	<b>2085</b>

Weekend		Phase 1 (P2/P4)	Parcel 1	Parcel 3	Parcel 5	Parcel 6	Parcel 7	P&R	Total
Parking Demand	Customer/Visitor	292	21	84	205	51	46	20	719
	Employee/Resident	51	5	15	25	0	0	0	96
	Reserved	50	0	0	0	418	376	0	844
	<b>Total</b>	<b>393</b>	<b>26</b>	<b>99</b>	<b>230</b>	<b>469</b>	<b>422</b>	<b>20</b>	<b>1659</b>

Note: P&R = Park-and-Ride

### Parking Needs Analysis Results – Buildout Scenario 3

Table 10 summarizes the results of the Buildout Scenario 3 parking needs analysis for weekdays.

**Table 10: Pflugerville Town Center Buildout Scenario 3 – Projected Peak Weekday Parking Demand**

Land Use	Project Data		Weekday					Weekday		
			Base Ratio	Driving Adj	Non-Captive Ratio	Project Ratio	Unit For Ratio	Peak Hr Adj	Peak Mo Adj	Estimated Parking Demand
	Quantity	Unit						2 PM	April	
Retail	20,500	sf GLA	2.90	97%	87%	2.44	ksf GLA	95%	67%	32
Employee			0.70	80%	98%	0.55		100%	77%	9
Fine/Casual Dining	5,000	sf GLA	13.25	97%	57%	7.30	ksf GLA	65%	94%	23
Employee			2.25	80%	98%	1.76		90%	100%	8
Family Restaurant	3,750	sf GLA	15.25	97%	57%	8.40	ksf GLA	50%	94%	15
Employee			2.15	80%	98%	1.68		100%	100%	7
Fast Casual/Fast Food	17,500	sf GLA	12.40	97%	41%	4.99	ksf GLA	90%	95%	74
Employee			2.00	80%	98%	1.56		95%	100%	26
Outdoor Amphitheater	250	seats	0.30	100%	10%	0.03	seat	1%	10%	-
Employee			0.07	80%	98%	0.05		30%	50%	2
Rec Center	128,210	sf GLA	2.00	100%	87%	1.74	ksf GLA	60%	100%	134
Employee			0.25	80%	98%	0.20		75%	100%	19
Hotel	120	keys	1.00	59%	100%	0.59	key	60%	100%	42
Hotel Employees	120	keys	0.15	80%	98%	0.12	key	100%	100%	14
Restaurant/Lounge	5,000	sf GLA	6.67	63%	90%	3.78	ksf GLA	33%	92%	6
Restaurant/Meeting Employee	5,000	sf GLA	1.20	80%	98%	0.94	ksf GLA	100%	100%	5
Residential										
Studio Efficiency	74	units	0.00	100%	100%	0.00	unit	50%	100%	-
1 Bedroom	368	units	0.00	100%	100%	0.00	unit	50%	100%	-
2 Bedrooms	293	units	0.00	100%	100%	0.00	unit	50%	100%	-
Reserved	100%	res spaces	1.19	100%	100%	1.19	unit	100%	100%	878
Visitor	735	units	0.10	97%	100%	0.10	unit	20%	100%	14
Office <25 ksf	14,000	sf GFA	0.30	97%	100%	0.29	ksf GFA	95%	100%	5
Employee			3.50	92%	95%	3.06		95%	100%	41
Office =100 ksf	100,000	sf GFA	0.25	97%	100%	0.24	ksf GFA	95%	100%	23
Employee			3.15	92%	95%	2.76		95%	100%	262
Government Office	89,750	sf GFA	1.19	97%	100%	1.15	ksf GFA	95%	100%	99
Reserved	1	emp	2.70	92%	100%	2.48		100%	100%	224
										Customer/Visitor 467
										Employee 393
										CH Fleet Vehicles 50
										Reserved CH Emp 6A-5P 224
										Reserved Resident 878
										<b>SubTotal 2,012</b>
										Park & Ride 6A-5P 200
										<b>Total with P&amp;R 2,212</b>

As shown in Table 10, the projected peak weekday parking demand for Buildout Scenario 3 is 2,212 spaces, and it is projected to occur at 2:00 p.m., including 200 spaces for a potential park-and-ride. Absent the park-and-ride, the projected peak weekday parking demand for Buildout Scenario 3 is 2,012 spaces.

Figure 7, on the next page, shows the projected accumulation of parking demand over the day on weekdays for Buildout Scenario 3.

**Figure 7: Pflugerville Buildout Scenario 3 Weekday Parking Demand by Hour**

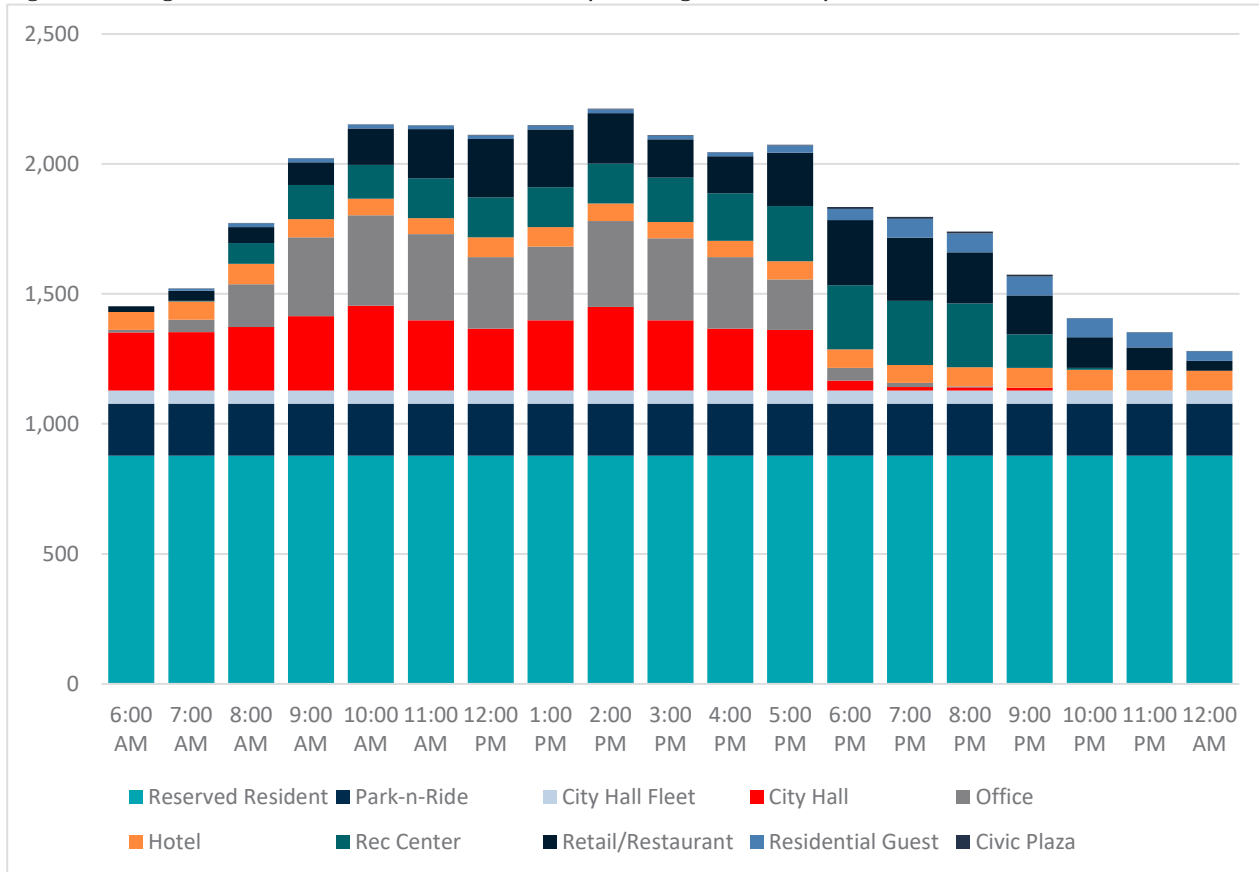


Table 11 summarizes the results of the Buildout Scenario 3 parking needs analysis for weekends.

**Table 11: Pflugerville Town Center Buildout Scenario 3 – Projected Peak Weekend Parking Demand**

Land Use	Project Data		Weekend					Weekend		
			Base Ratio	Driving Adj	Non-Captive Ratio	Project Ratio	Unit For Ratio	Peak Hr Adj	Peak Mo Adj	Estimated Parking Demand
	7 PM	October								
Retail Employee	20,500	sf GLA	3.20	97%	88%	2.74	ksf GLA	70%	69%	27
			0.80	80%	98%	0.62		80%	78%	8
Fine/Casual Dining Employee	5,000	sf GLA	15.25	97%	80%	11.79	ksf GLA	95%	93%	52
			2.50	80%	98%	1.95		100%	100%	10
Family Restaurant Employee	3,750	sf GLA	15.00	97%	80%	11.60	ksf GLA	70%	93%	29
			2.10	80%	98%	1.64		95%	100%	6
Fast Casual/Fast Food Employee	17,500	sf GLA	12.70	97%	65%	8.05	ksf GLA	80%	96%	109
			2.00	80%	98%	1.56		90%	100%	25
Outdoor Amphitheater Employee	250	seats	0.33	100%	33%	0.11	seat	25%	50%	3
			0.07	80%	98%	0.05		100%	60%	8
Rec Center Employee	128,210	sf GLA	2.00	100%	88%	1.76	ksf GLA	100%	100%	227
			0.25	80%	98%	0.20		100%	100%	26
Hotel	120	keys	1.00	69%	100%	0.69	key	75%	95%	59
Hotel Employees	120	keys	0.15	80%	98%	0.12	key	20%	95%	3
Restaurant/Lounge	5,000	sf GLA	7.67	54%	30%	1.24	ksf GLA	60%	96%	4
Restaurant/Meeting Employee	5,000	sf GLA	1.33	80%	98%	1.04	ksf GLA	100%	100%	5
Residential										
Studio Efficiency	74	units	0.00	100%	100%	0.00	unit	55%	100%	-
1 Bedroom	368	units	0.00	100%	100%	0.00	unit	55%	100%	-
2 Bedrooms	293	units	0.00	100%	100%	0.00	unit	55%	100%	-
Reserved	100%	res spaces	1.19	100%	100%	1.19	unit	100%	100%	878
Visitor	735	units	0.15	97%	100%	0.15	unit	100%	100%	108
Office <25 ksf Employee	14,000	sf GFA	0.03	97%	100%	0.03	ksf GFA	0%	100%	-
			0.35	92%	95%	0.31		0%	100%	-
Office =100 ksf Employee	100,000	sf GFA	0.03	97%	100%	0.03	ksf GFA	0%	100%	-
			0.32	92%	95%	0.28		0%	100%	-
Government Office	89,750	sf GFA	0.00	97%	100%	0.00	ksf GFA	0%	100%	-
Reserved	1	emp	0.00	92%	100%	0.00		0%	100%	-
								Customer/Visitor		618
								Employee		91
								CH Fleet Vehicles		50
								Reserved CH Emp 6A-5P		-
								<u>Reserved Resident</u>		<u>878</u>
								<b>SubTotal</b>		<b>1,637</b>
								Park & Ride 6A-5P		20
								<i>Total with P&amp;R</i>		<i>1,657</i>

As shown in Table 11, the projected peak weekend parking demand for Buildout Scenario 3 is 1,657 parking spaces, projected to occur at 7:00 p.m., including 20 spaces for a potential park-and-ride. Absent the park-and-ride, the projected peak weekend parking demand for Buildout Scenario 3 is 1,637 spaces.

Figure 8 shows the projected accumulation of parking demand over the day on the weekend for Buildout Scenario 3.

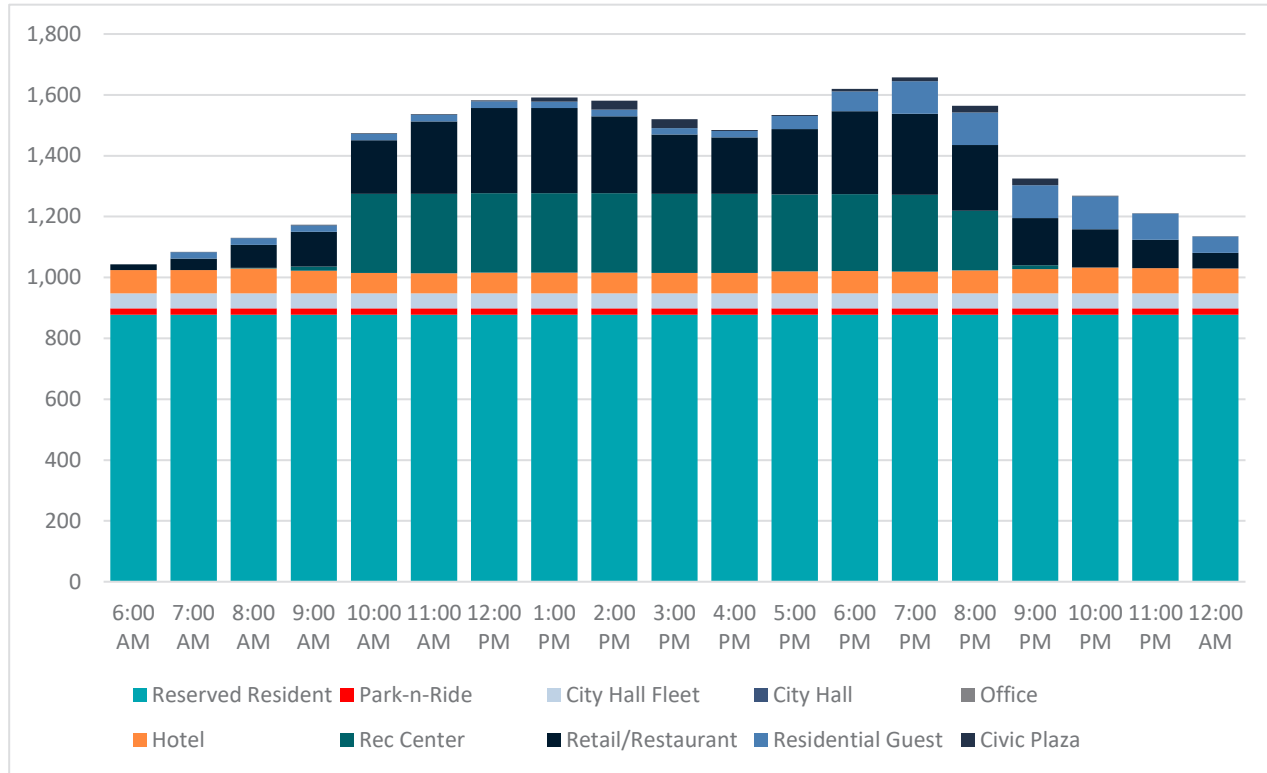
**Figure 8: Pflugerville Buildout Scenario 3 Weekend Parking Demand by Hour**


Table 12 summarizes Buildout Scenario 3 parking needs at peak, by parcel.

**Table 12: Pflugerville Town Center Buildout Scenario 3 – Distribution of Peak Demand by Parcel**

Weekday		Phase 1 (P2/P4)	Parcel 1	Parcel 3	Parcel 5	Parcel 6	Parcel 7	P&R	Total
Parking Demand	Customer/Visitor	279	43	48	64	27	6	200	667
	Employee/Resident	77	16	19	19	262	0	0	393
	Reserved	274	0	0	263	239	376	0	1152
	<b>Total</b>	<b>630</b>	<b>59</b>	<b>67</b>	<b>346</b>	<b>528</b>	<b>382</b>	<b>200</b>	<b>2212</b>
Weekend		Phase 1 (P2/P4)	Parcel 1	Parcel 3	Parcel 5	Parcel 6	Parcel 7	P&R	Total
Parking Demand	Customer/Visitor	290	62	63	128	29	46	20	638
	Employee/Resident	48	14	8	21	0	0	0	91
	Reserved	50	0	0	263	239	376	0	928
	<b>Total</b>	<b>388</b>	<b>76</b>	<b>71</b>	<b>412</b>	<b>268</b>	<b>422</b>	<b>20</b>	<b>1657</b>

Note: P&R = Park-and-Ride