

Tree Technical Manual: Standards & Specifications

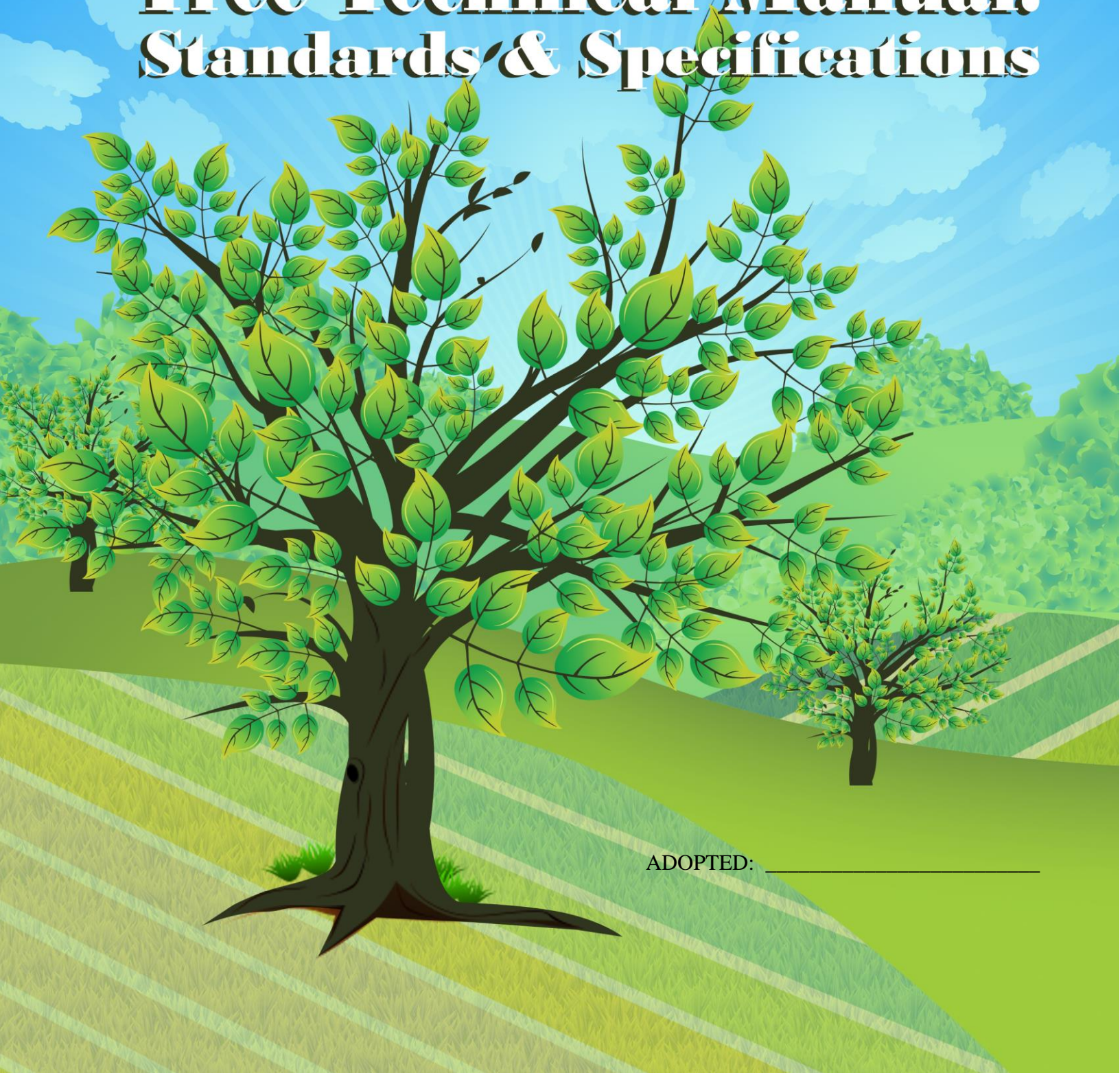

ADOPTED: _____

TABLE OF CONTENTS

Introduction	5
Section 1: Tree Survey Standards.....	6
1.1. Introduction	6
1.2. Protected and unprotected trees.....	6
1.3. Tree survey required	7
1.4. Tree survey certification	7
1.5. Information to be gathered in the field.....	7
1.6. Information to be provided on the tree survey.....	8
1.7. Additional information.....	9
Section 2: Tree Protection Standards	11
2.1. Introduction	11
2.2. Critical Root Zone (CRZ).....	11
2.3. Tree Protection and Preservation Plan & pre-construction requirements	12
2.3.1. Site plan reflecting Critical Root Zones	12
2.3.2. Tree protection notes	13
2.3.3. Exceptions to Construction within Critical Root Zone (CRZ).....	14
2.3.4. Intent of Tree Fencing for Protected Trees	15
2.3.5. Tree Fencing for Protected Trees Standards	16
2.4. Tree pruning, tree surgery, and removal prior to construction	20
2.5. Activities during construction and demolition near trees	20
2.5.1. Soil compaction	20
2.5.2. Grading limitations within the Critical Root Zone.....	20
2.5.3. Trenching, excavation, and equipment use.....	21
2.5.4. Tunneling and directional drilling.....	22
2.5.5. Construction impact mitigation	23
2.6. Damage to trees.....	24
2.6.1. Reporting.....	24
2.6.2. Penalty for damage to protected trees	24
2.7. Pavement and hardscape conflicts with tree roots.....	25
2.7.1. Removal and replacement of pavement and sidewalks	25
2.7.2. Alternative methods to prevent root cutting (Recommended)	25
2.7.3. Avoiding conflicts (Recommended).....	25
2.7.4. Alternative base course material (Recommended)	25
Section 3: Tree Removal, Replacement, Planting, and Maintenance Standards	26
3.1. Introduction	26
3.2. Tree removal	26
3.2.1. Allowable removal	26
3.2.2. Protected Tree Removal Permit Application	26

3.3. Tree replacement plan	26
3.4. Tree planting requirements	27
3.4.1. Species.....	27
3.4.2. Planting distances/spacing requirements	28
3.5. Tree stock and materials	28
3.5.1. Quality	28
3.5.2. Container grown/ ball and burlapped trees	29
3.5.3. Miscellaneous materials	29
3.6. Planting site preparation	29
3.6.1. Soil preparation and conditioning	29
3.6.2. Planter pit preparation	29
3.6.3. Drainage.....	30
3.7. Planting the tree	30
3.7.1. Container grown trees	30
3.7.2. Ball and burlapped trees	30
3.7.3. Backfill soil, amended soil	31
3.7.4. Filling the hole	31
3.7.5. Constructing a berm or dam.....	31
3.7.6. Mulching.....	31
3.7.7. Staking or guying.....	31
3.8. Transplanting trees	33
3.9. Irrigation	34
3.10. Maintenance.....	35
Section 4: Tree Pruning, Surgery, and Maintenance	36
4.1. General Tree Pruning and Surgery	36
4.1.1. Pruning.....	36
4.1.2. Certified Arborist Required	36
4.1.3. Time of Year for Pruning	36
4.1.4. Pruning Limitations.....	36
4.1.5. Types of Pruning	37
4.1.6. Types of Pruning Prohibited	39
4.1.7. Making Proper Pruning Cuts	39
4.1.8. Tree surgery.....	40
4.1.9. Tree removal adjacent to protected trees.....	40
4.2. Pruning New Planted Trees	40
4.2.1. Types of Pruning Prohibited	40
4.2.2. Pruning guidelines (Recommended)	40
4.2.3. Limb removal (Recommended)	41
Section 5: Administration, Inspection, and Enforcement	42
5.1. Administration	42
5.2. Inspection.....	42
5.2.1. Inspection by owner	42

5.2.2. Inspection by city representative 42
5.3. Enforcement..... 43

Appendix

A. Definitions.....A-1
B. Bibliography.....B-1
C. Tree Protection Construction Details..... C-1

INTRODUCTION

Trees provide numerous benefits to quality of life in the urban area, such as beautification, storm water absorption, energy conservation, and increased property values. The City's historic ecotype is blackland prairie, most of which was transitioned to farmland. Few remnants of native vegetation remain; these can be found in the floodplain basins of the Gilleland Creek and Wilbarger watersheds, and along the MoKan right-of-way. The most common native vegetation is the tallgrasses and wildflowers of the blackland prairie, and the elms, and pecans of the floodplains.

This Tree Technical Manual will refer to *Subchapter 11, Landscaping and Screening Standards and Subchapter 12, Tree Preservation Standards of the Unified Development Code*. The Tree Technical Manual and Subchapter 12, Tree Preservation Standards of the UDC are the City's primary regulatory tools to provide for orderly protection of specified trees to promote the health, safety, welfare, and quality of life for the residents of the City, to promote the safe, orderly and healthful development of the City, to protect property values, and to avoid significant negative impacts on adjacent properties. By assuring preservation and protection of trees through regulations and standards of care, these resources will remain significant contributions to the landscape, streets and parks, and continue to help define the unique character of the City.

This *Tree Technical Manual* (the Manual) is adopted by City Council by ordinance and is maintained by the Planning Department with distribution by the City Forester. The Manual provides standards and specifications based on generally accepted practices and provides guidelines for survey, protection, planting, pruning and irrigation of trees. If there appears to be a conflict in verbiage between the UDC and the Manual, the UDC will take precedence. The goals of the Manual are intended to provide consistent care and serve as benchmarks to measure achievement in the following areas:

- ❖ Ensure and promote preservation of the remaining tree canopy cover within the City limits and in the ETJ;
- ❖ Provide standardized presentation of tree survey data required by the City;
- ❖ Maintain the health and vigor of trees during and after construction events by providing protection standards and best management practices;
- ❖ Provide standards for the replacement of trees that are permitted to be removed;
- ❖ Provide standards for new tree planting, tree care and irrigation; and
- ❖ Provide guidance on protection, planting, and care of trees in the City's right-of-way and publicly owned lands.

PRIMARY SOURCES CONSULTED

Standards and specifications were gathered from various sources as listed in the bibliography. The International Society of Arboriculture (ISA) material was used for much of the tree planting, pruning, and general tree care information. The *Tree Technical Manual* produced by the City of Palo Alto, California and Round Rock, Texas were used to develop the standards provided within the Manual. The standards in this Manual are based on common practices in the area and the types of soils and trees that exist in the City.

SECTION 1: TREE SURVEY STANDARDS

1.1. INTRODUCTION

This section describes the format of tree surveys, as well as the types of tree identification required in the field. These standards and specifications assure a faster review process as they relate to tree protection and mitigation.

1.2. PROTECTED AND UNPROTECTED TREES

Trees of all species that are at least eight (8) inches in diameter are protected, except for Chinaberry, Hackberry, Ashe Juniper (Cedar), Chinese Tallow, Willow, Ligustrum, Mimosa, Cottonwood, Huisache and other exceptions provided in Subchapter 12 of the Unified Development Code (UDC). If there are any discrepancies between the Manual and the UDC, the UDC shall govern. For details related to protected trees, refer to Subchapter 12 of the UDC.

Per Subchapter 12 of the Unified Development Code, there are five tree classifications based on size or designation.

Tree Classifications	Description	Mitigation Ratio (Replacement Inches: Removed Inches)	Credit Ratio (Preserved Inches: Credit Inches)
Class 1	Unprotected Tree - Tree with DBH* < 8 inches (unless tree was planted to satisfy requirements of Subchapter 11)	N/A	Refer to the UDC
Class 2	Tree with DBH 8 - 17.99 inches; and Trees planted to satisfy requirements of Subchapter 11	1:1	
Class 3	Tree with DBH 18 – 24.99 inches	2:1	
Class 4	Tree with DBH 25 inches or more	2.5:1	
Class 5	"Heritage Tree" - Tree with DBH 25 inches or more	3:1	

*Diameter at Breast Height (See Illustration 1-1)

The first classification may include trees with diameters up to 7.99 inches DBH; trees less than eight (8) inches in diameter are not protected unless the tree was planted to satisfy the requirements of Subchapter 11 of the Unified Development Code. The trees selected for mitigation or tree credit shall be indicated on the tree survey within a site plan, site disturbance plan, and construction plans.

The second classification includes trees 8-17.99 inches DBH and trees planted to satisfy the requirements of Subchapter 11 of the Unified Development Code.

The third classification includes trees 18-24.99 inches DBH.

The fourth classification includes trees 25 inches and greater DBH, of non-heritage tree species per Subchapter 12 of the Unified Development Code.

The fifth classification includes Heritage Trees: these are trees with diameters of 25 inches and above. Refer to heritage tree species within Subchapter 12 of the Unified Development Code.

1.3 TREE SURVEYS REQUIRED

Tree surveys are required at all phases of development including, but not limited to: preliminary plan, construction plan, site disturbance plan, and site plan.

1.4 TREE SURVEY CERTIFICATION

All tree surveys shall be prepared by a certified arborist, registered landscape architect or registered professional land surveyor. All trees, regardless of species eight (8) inches in diameter and above shall be surveyed and reflected on the survey graphically and in the legend. Ensure all trees within a required bufferyard per Ordinance are identified as they are protected regardless of species or size. Trees less than eight (8) inches in diameter that are proposed for preservation and landscape credit shall also be included in the tree survey and legend.

If it is found upon field inspection that the survey is inaccurate, the tree survey will not be accepted or reviewed, and it will be returned for corrections. This will delay the respective development application review process while the tree survey is corrected.

1.5. INFORMATION TO BE GATHERED IN THE FIELD

The data required to be collected and illustrated in the preliminary plan, construction plan, site disturbance plan, and site plan include tree locations, diameters, species, limits of construction, and certain tree graphics.

1. **Location-** Tree data submitted must be obtained from a ground survey. A number shall be assigned and a corresponding numbered tag placed on each tree surveyed and provided in the overall tree survey. Tree numbers will remain on the trees until the project has received its certificate of occupancy in the City or acceptance of public infrastructure associated with a construction plan in the ETJ.
2. **Diameter-** Diameters of existing trees are measured as follows. Diameter measurement shall be recorded to the nearest inch. Trees may be measured with a caliper, cruise stick, standard tape measure or diameter tape.
 - a. Straight trunk: Trees with fairly straight, upright trunks should be measured four and a half (4.5) feet above the ground (See illustration 1-1 A).

Illustration 1-1 A-D: Measurement of trees

From: Guide for Plant Appraisals, 9th ed.

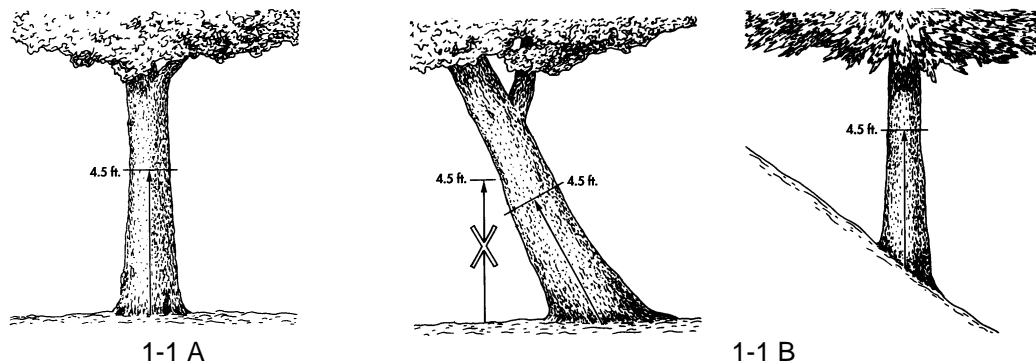

- b. Trunk on an angle or on a slope: The trunk is measured at right angles to the trunk four and a half (4.5) feet along the center of the trunk axis, so the height is the average of the shortest and the longest sides of the trunk (see Illustration 1-1 B).
- c. Trunk branching lower than four and a half (4.5) feet from the ground: When branching begins less than four and a half (4.5) feet from the ground, measure the smallest circumference below the lowest branch. In this example, an alternative would be to add the sum of the cross-sectional areas of the two stems measured about 12 inches above the crotch. Then average the sum of these two branch areas and the smallest cross-sectional area below the branches. This may give a better estimate of the tree size (see Illustration 1-1 C).

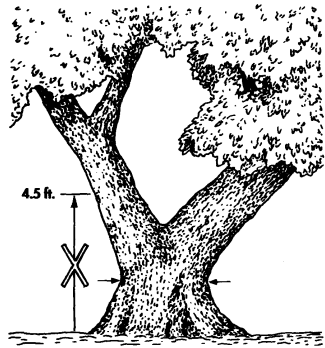

1-1 C

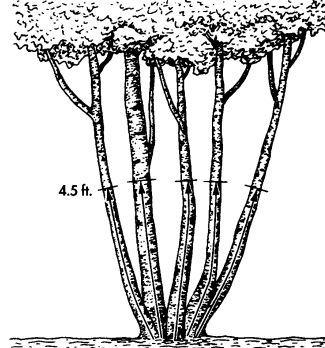

1-1 D

- d. Multi-stemmed tree: To determine the diameter of a multi-trunk tree, measure all the trunks; add the total diameter of the largest trunk to one-half (1/2) the diameter of each additional trunk (see Illustration 1-1 D). A multi-trunked tree is differentiated from individual trees growing from a common root stock if there is a visible connection between the trunks above ground.

- 3. **Species-** The name of the species, such as Live Oak, Cedar Elm, or Pecan, should be accurately reflected. Tree types should be listed by common names and Latin names, however common names shall be required. Indicating a tree name as “unknown” on a tree survey is not acceptable.

1.6. INFORMATION TO BE PROVIDED ON THE TREE SURVEY

- 1. **Trunk location-** The trunk location on the plan must represent the center of the trunk at ground level in the field. If the tree leans substantially above that point, show the direction of the lean with an arrow. See the legend under the sample Tree Survey in Illustration 1-2 for an example.
- 2. **Critical Root Zone (CRZ)-** Trees are to be represented on the tree survey by a concentric circle centered on the trunk location, with a radius equal in feet to the number of inches of the tree’s trunk diameter. For example, an oak tree with a trunk diameter measuring fifteen (15) inches would be represented to scale on the tree survey with a circle representing a fifteen (15) foot radius. Trees to be retained will be represented by a solid circle. Trees to be removed are to be represented by a dashed circle. See Illustration 1-2.
- 3. **Diameters and types of existing trees-** Tree diameters and types shall be shown on the survey within a legend. Tree numbers on the legend shall correlate with the

appropriate tree circle drawn on the plan and the trees in the field. Special conditions such as “dead” shall be noted.

4. **Tree numbers-** Tree numbers on the plan shall correlate with tags assigned to trees during the survey.
5. **Tree survey table -** A table will be included listing all surveyed trees by number, species, size, protection status, removal status, health conditions, and creditable trees under eight inches. Additionally, it will include calculations of the number of inches to be removed with and without mitigation, and number of inches credited. See illustration 1-2 for reference.

1.7. ADDITIONAL INFORMATION

There are other types of information related to tree structure and condition which may affect site plan design. The City Forester or Administrator may request these types of information. The information will be expressed as a written note on the survey and include the tree number and a description of any of the following:

1. **Crown configuration-** If a tree has a crown which is skewed in one direction, this information would be useful for surveyors to note. Project designers and plan reviewers need such information to more accurately assess design impacts on such trees.
2. **Crown clearance-** This information is often critical in determining whether a given structure or vehicular use area can practically be placed within the dripline of a tree. If this information is recorded, the surveyor should consider the vertical distance to any major branches.
3. **Condition-** This is one of the principle factors in determining whether a tree should or should not be preserved. Surveyors should not speculate about the condition of all trees unless they have the necessary credentials; however, if a tree is obviously in poor condition, it should be noted to prevent unnecessary expense in trying to design around it.
4. **Spot elevation-** Taking an elevation reading near the trunks of some trees will provide valuable information for project designers. Since grade changes are the most destructive impacts on trees, it is important to get the most accurate information possible. If there is more than a six-inch change, existing and proposed grade elevation will need to be reflected on the tree survey.

Illustration 1-2: Elements of a Tree Survey and Tree Protection Plan

TREE SURVEY							
Protection Status and Class	Proposed Removal (X) or Credit (C)	Tree #	Size (inches) - Species	Mitigation (Replacement Inches: Removed Inches)		Credit (Preserved Inches: Credit Inches)	
				Ratio	Inches Required	Ratio	Inches Credit
NP - Class 1	C	1	4" – Live Oak			1:1	4
NP - Class 1	X	2	10" – Hackberry	N/A	0		
P - Class 2	X	3	16" – Post Oak	1:1	16		
P - Class 5	X	4	36" – Cedar Elm	3:1	108		
P - Class 3	X	5	20" – Live Oak	2:1	40		
P - Class 5	X	7	40" – Live Oak, Dead	N/A	0		
NP - Class 1	C	8	6" – Mountain Laurel			1:1	6
P - Class 3	C	9	18" – Pecan			2:1	9
NP - Class 1	C	10	7" – Pecan			1:1	7
NP - Class 1	C	12	4" – Bur Oak			1:1	4
Total Inches Mitigation and Credit					164		30
Mitigation – Credit = Diameter inches proposed for mitigation or applied towards landscaping requirements				164-30= 134 inches mitigation required			
LEGEND							
Not Protected (NP)		Protected (P)		Tree Removal (X)		Tree Credit (C)	
No credit shall be given for Chinaberry, Hackberry, Ashe Juniper (Cedar), Chinese Tallow, Willow, Ligustrum, Mimosa, Cottonwood, Huisache trees, or any other unprotected trees per Subchapter 12 of the Unified Development Code.							

Illustration 1-2: Elements of a Tree Survey (continued):

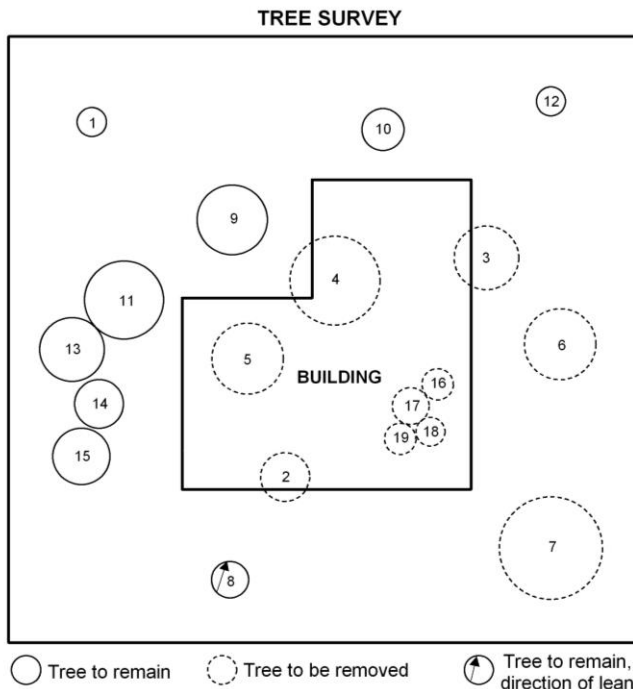

SECTION 2: TREE PROTECTION STANDARDS

2.1. INTRODUCTION

The tree protection section of the Ordinance and the standards in this section are provided to ensure that appropriate practices will be implemented in the field to eliminate undesirable consequences that may result from uninformed or careless acts, and preserve both trees and property values. Construction projects are required to implement the protective practices described in this section.

Typical negative impacts that may occur during construction include:

- ❖ Mechanical injury to roots, trunk or branches
- ❖ Compaction of soil, which degrades the functioning roots, inhibits the development of new ones, restricts drainage and soil function
- ❖ Changes in existing grade which can remove or suffocate roots
- ❖ Alteration of the water table - either raising or lowering
- ❖ Microclimate change, exposing sheltered trees to sun or wind
- ❖ Sterile soil conditions, associated with stripping off topsoil

2.2. CRITICAL ROOT ZONE (CRZ)

Each tree to be retained shall have a designated Critical Root Zone (CRZ) identifying the area sufficiently large enough to protect the tree and roots from disturbance. The Critical Root Zone is one foot of radial distance from the base of the tree for every inch of tree Diameter at Breast Height (DBH). The CRZ shall be shown on all tree surveys, tree protection plans, tree replacement plans, and construction plans. Improvements or activities such as paving, utility and irrigation trenching and other activities shall occur outside the CRZ, unless authorized by the City Forester or Administrator. Unless otherwise specified, the protective fencing shall be placed at the dripline or the CRZ, whichever is greater.

Illustration 2-1: Root zone vs. Critical root zone (CRZ)

From: *Urban Forest Management Plan*.

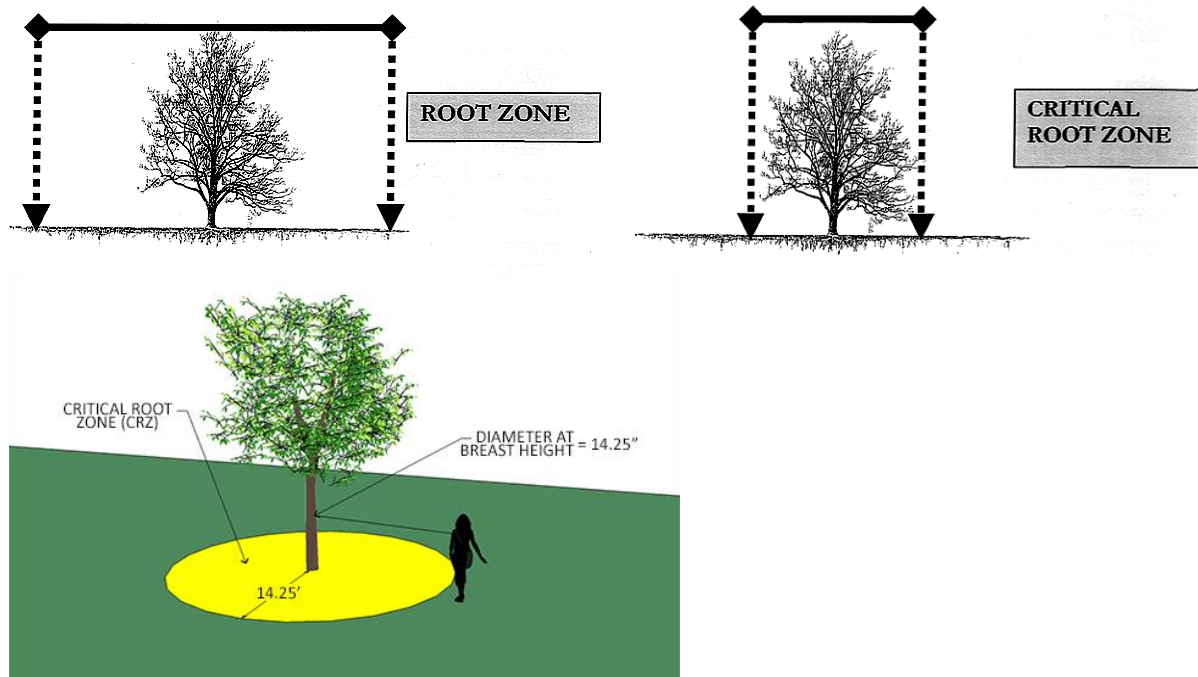

2.2.1. Activities prohibited within the CRZ include:

- Storage or parking vehicles, building materials, refuse, excavated spoils or dumping of poisonous materials on or around trees and roots. Poisonous materials include, but are not limited to, paint, petroleum products, concrete or stucco mix, dirty water or any other material which may be harmful to tree health
- The use of tree trunks as a winch support, anchorage, temporary power pole, sign posts or other similar function
- Cutting of tree roots by utility trenching, foundation digging, placement of curbs and trenches and other miscellaneous excavation without prior approval of the City Forester or Administrator.
- Soil disturbance or grade change
- Impervious paving
- Vehicular traffic
- Drainage changes

2.2.2. Activities permitted or required within the CRZ include:

- Mulching. During construction, mulch may be required to be spread within the CRZ. The mulch may be removed if improvements or other landscaping is required. Where there are areas of unprotected root zones in the CRZ, those areas shall be covered with four (4) to six (6) inches of organic mulch to minimize soil compaction. See Section 3 of this Manual for a more thorough discussion on mulching.
- Irrigation, aeration, fertilizing or other beneficial practices that have been specifically approved for use within the CRZ and as defined by the City Forester.

2.2.3. Erosion Control Near Preserved Trees:

If a tree is adjacent to or in the immediate proximity to a grade slope of 8% (23 degrees) or more, then approved erosion control or silt barriers shall be installed outside the CRZ to prevent siltation and/or erosion within the CRZ.

2.3. TREE PROTECTION AND PRESERVATION PLAN & PRE-CONSTRUCTION REQUIREMENTS

Prior to the start of any development project, the property owner shall have prepared and submitted for review a Tree Protection Plan for all protected trees. Tree protection shall be represented on the preliminary plan, construction plan, site disturbance plan, and site plans. The Tree Protection Plan shall consist of three elements:

1. Construction details showing options in tree fencing and protection (Refer to construction details within this section related to fencing and protection and provided within the Appendix.)
2. Tree protection notes as listed in section 2.3.2 and 2.3.3 of this Manual, as applicable.
3. Tree protection symbols on the Tree Protection Plan as discussed in section 2.3.1 and illustrated in Illustration 2-2 of this Manual.

The plan will be reviewed by the City Forester and/ or Administrator. The following elements will be addressed in the Tree Protection Plan prior to construction:

2.3.1. Site Plan Reflecting Critical Root Zones- In addition to the requirements described in the Tree Survey Standards, the CRZ to be enclosed with the specified tree fencing shall be indicated on the Tree Replacement Plan and all construction plans as illustrated in figure 2-2.

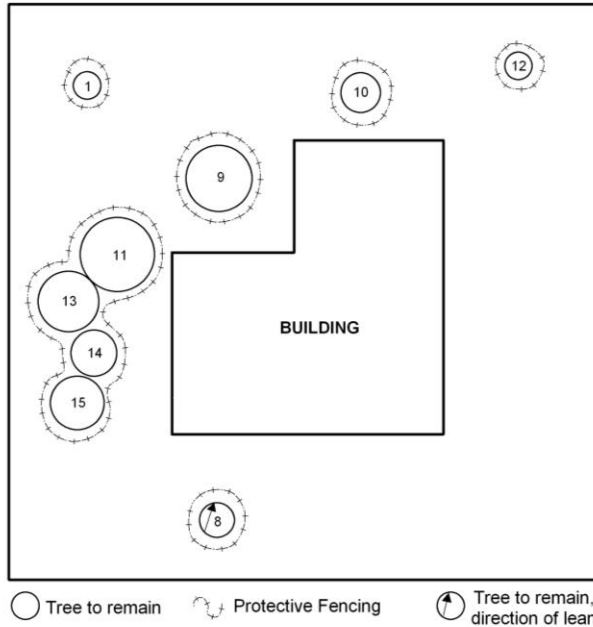

Illustration 2-2: Site plan with tree protection fence illustrated. Circles illustrate the Critical Root Zone.

2.3.2. Standard Tree Protection Notes- The preliminary plan, construction plan, site disturbance plan, and site plan shall reflect the following tree protection notes. The following notes must be shown on plans accompanied by the standard tree protection construction details provided within Appendix C.

1. All trees not located within the limits of construction and outside of disturbed areas shall be preserved.
2. All trees shown on this plan to be retained shall be protected during construction with fencing consistent with the City's construction detail(s).
3. Tree protection fences shall be erected according to City standards for tree protection, fence material, and fence signage.
4. Tree protection fences shall be installed prior to the commencement of any site preparation work (clearing, grubbing, or grading) and shall be maintained throughout all phases of the construction project consistent with the approved plan.
5. Erosion and sedimentation control barriers shall be installed and maintained in a manner which does not result in trenching or soil build-up within a tree's Critical Root Zone (CRZ) or driplines, whichever is greater.
6. **(STANDARD)** Tree protection fences shall completely surround the tree or clusters of trees and be placed at the outermost limits of the tree branches (dripline) or CRZ, whichever is greater; and shall be maintained throughout the construction project in order to prevent the following:
 - a. Soil compaction in root zone area resulting from vehicular traffic or storage of equipment or material.
 - b. Root zone disturbances due to grade changes (greater than 6 inches cut or fill) or trenching not reviewed and authorized by the City Forester or Administrator.
 - c. Wounds to exposed roots, trunk, or limbs by mechanical equipment
 - d. Other activities detrimental to trees, such as chemical storage, concrete truck cleaning and fires.
7. Any roots exposed by construction activity shall be pruned flush with the soil. Backfill root areas with good quality top soil. If exposed root areas are not backfilled within 2 days, cover them with organic material in a manner which reduces soil temperature and minimizes water loss due to evaporation.
8. When construction occurs immediately outside of the CRZ or dripline of a preserved tree, a clean cut shall be made between the disturbed and undisturbed root zones

- with a rock saw or similar equipment prior to excavation or grade cutting. The purpose of this provision is to minimize damage to the remaining roots of preserved trees. The contractor shall contact the City Forester or Administrator for supervision.
9. When installing concrete adjacent to the root zone of a tree, use a plastic vapor barrier behind the concrete to prohibit leaching of lime into the root zone.
 10. Any trenching shall be as far from existing tree trunks as possible. Trench lines shall not run within the CRZ. Boring, tunneling or other techniques may be approved by the City Forester or Administrator if there are no other alternatives available.
 11. No landscape topsoil dressing greater than six (6) inches shall be permitted within the dripline or CRZ, whichever is greater, of trees. No topsoil is permitted on root flares or within 6 inches of tree trunks.
 12. Pruning to provide clearance for structures, vehicular traffic and construction equipment shall take place before construction begins. All pruning must be done according to City standards pursuant to Section 4 of the Tree Technical Manual and as outlined in literature provided by the International Society of Arboriculture (ISA pruning techniques).
 13. All oak tree cuts, intentional or unintentional, shall be painted immediately (within 10 minutes). Tree paint must be kept on site at all times. All pruning or cutting tools must be sterilized between trees to prevent the spread of disease.
 14. Trees approved for removal shall be removed in a manner which does not impact trees to be preserved. Refer to the City of Pflugerville *Tree Technical Manual* for appropriate removal methods.
 15. Deviations from the above notes are considered ordinance violations if there is substantial noncompliance or if a tree sustains damage as a result.
 16. **(PRE-CONSTRUCTION CONFERENCE)** The demolition, grading and underground contractors, construction superintendent and other pertinent personnel are required to meet with the City Forester and/or Administrator prior to beginning work to review procedures, tree protection measures and to establish haul routes, staging areas, contacts, watering, etc.
 17. **(VERIFICATION OF TREE PROTECTION)** The project arborist, landscape architect or contractor shall verify, in writing, that all preconstruction conditions have been met (tree fencing, erosion control, pruning, etc.) and are in place. Written verification must be submitted to and approved by the City Forester or the Administrator before demolition or grading begins.

2.3.3 Exceptions to Construction within the Critical Root Zone (CRZ)

1. If approved by the City Forester, exceptions to installing tree fences at the tree driplines or CRZ, whichever is greater, may be permitted in the following cases:
 1. Where there is to be an approved grade change, impermeable paving surface, or tree well.
 2. Where permeable paving is to be installed, erect the fence at the outer limits of the permeable paving area.
 3. Where trees are close to proposed buildings, erect the fence no closer than 6 feet to the building, provided that the fence does not encroach into the CRZ by 50% measured from the base of the tree, and fencing remains a minimum of 5' from the base of the tree.
 4. Where there are severe space constraints due to tract size, or other special requirements, contact the City Forester to discuss alternatives.
2. Where any of the above exceptions result in a fence that is closer than 5 feet to a tree trunk, protect the trunk with strapped-on planking to a height of 8 feet (or to the limits of lower branching) in addition to the reduced fencing provided pursuant to tree protection construction detail.
3. Where any of the above exceptions result in areas of unprotected root zones under the dripline or CRZ, whichever is greater, those areas should be covered with four (4) to six (6) inches of organic mulch to minimize soil compaction.
4. Where any of the above exceptions result in damage to the fine, water absorbing

roots, supplemental watering shall be required:

1. Trees shall be watered once every two weeks during periods of hot, dry weather.
2. Tree crowns are to be sprayed with water periodically to reduce dust accumulation on leaves.
3. A signed watering contract shall be required prior to the start of construction.
5. Prior to excavation or grade cutting within tree driplines, a clean cut shall be made between the disturbed and undisturbed root zones with a rock saw or similar equipment to minimize damage to remaining roots. The contractor shall contact the City Forester or Administrator for supervision.
6. All grading within protected root zone areas shall be done by hand or with small equipment to minimize root damage. Prior to grading, relocate protective fencing to 2 feet behind the grade change area.

2.3.4. Intent of Tree Fencing for Protected Trees: Fenced enclosures shall be installed at the CRZ or the dripline, whichever is greater, to achieve three primary goals:

1. To keep the foliage crowns and branching structure clear from contact by equipment, materials and activities.
2. To preserve roots and soil conditions in an intact and non-compacted state.
3. To identify the Critical Root Zone (CRZ) in which no soil disturbance is permitted and activities are restricted, unless otherwise approved.

2.3.5. Tree Fencing for Protected Trees Standards:

1. Areas to be fenced

a. **Type I Tree Protection (Standard)**

The fences shall enclose the entire area under the **dripline** or **CRZ**, whichever is larger, of the tree(s) to be saved throughout the life of the project, or until final improvement work within the area is required, typically near the end of the project. Parking Areas: If the fencing must be located on paving or sidewalk that will not be demolished, the posts may be supported by an appropriate grade level concrete base.

Type I Tree Protection (Standard)

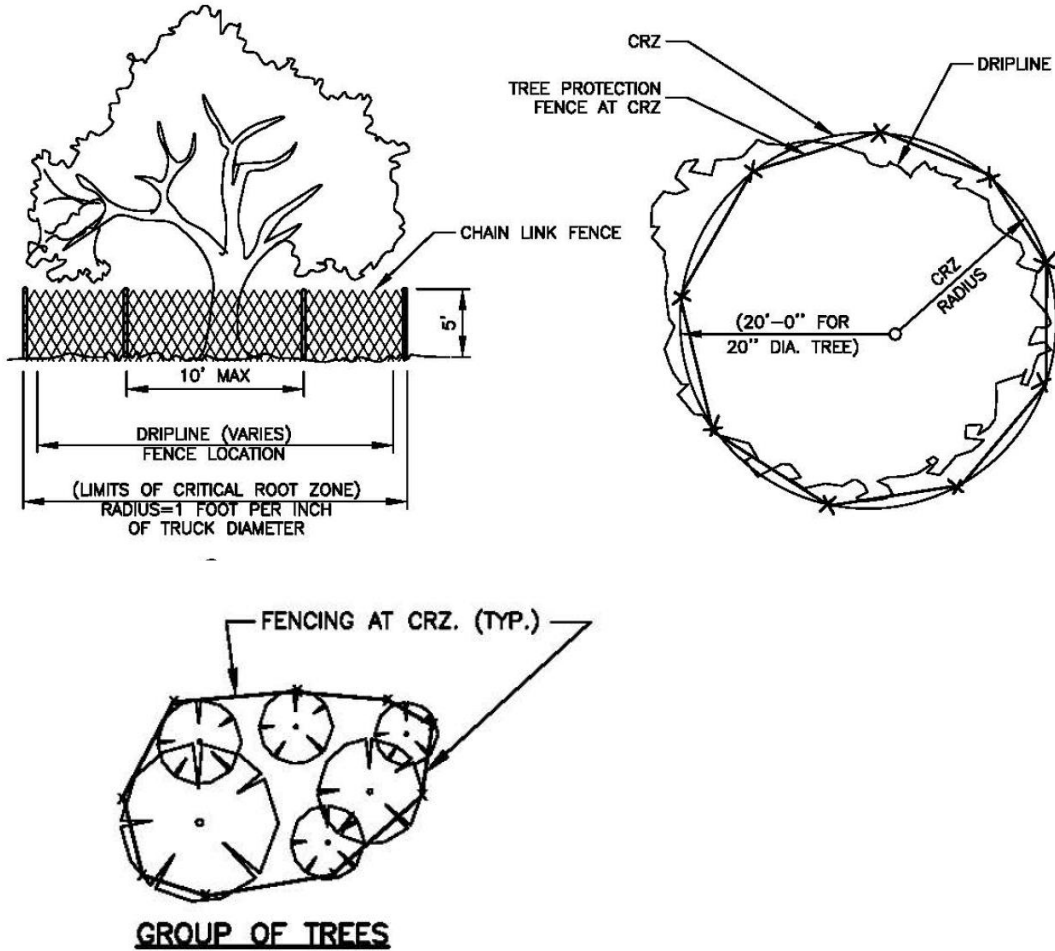

b. **Type II Tree Protection (Exception - 1)**

For trees **situated near buildings**, partial fencing within the CRZ may be necessary. For trees situated within a **narrow planting strip**, only the planting strip shall be enclosed with the required chain link in order to keep the sidewalk and street open for public use. The City Forester may approve this exception provided it meets the criteria provided within this Section. See Illustrations for Type II Tree Protection Fencing as provided below.

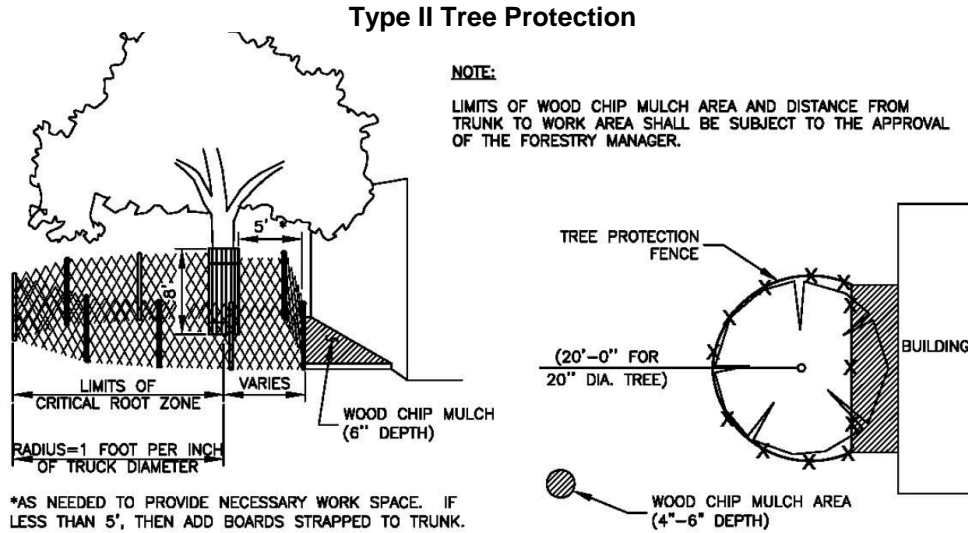

Exceptions to fencing along the CRZ

- Where permeable paving is to be installed, erect the fence at the outer limits of the permeable area
- Where trees are close to proposed buildings, erect the fence no closer than six (6) feet to the building, provided the fencing does not encroach by 50% within the CRZ, and fencing remains a minimum of 5' feet from the base of the tree.
- Where there are severe space constraints due to tract size, or other special requirements, contact the City Forester.

c. **Type III Tree Protection (Exception - 2)**

Trees situated in a small tree well or **sidewalk planter pit**, or when (above ground, no grading or trenching within CRZ) construction will come within five (5) feet of a trunk, shall have the trunk protected with strapped-on planking to a height of eight (8) feet or to the limits of lower branches. During installation of the wood slats, caution shall be used to avoid damaging any bark or branches. Major scaffold limbs may also need protection as directed by the City Forester.

Example of bark protection—done when CRZ is less than an 8 foot diameter, upon approval by the City Forester.

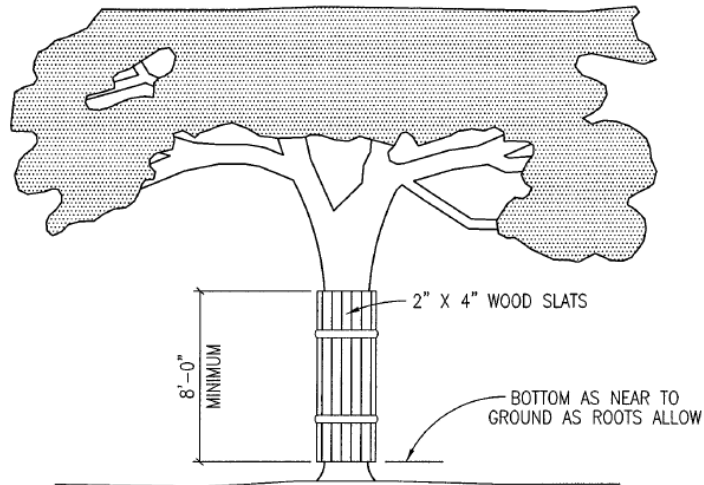

d. **Miscellaneous Tree Protection**

Other tree protective fencing configurations may be approved by the City Forester.

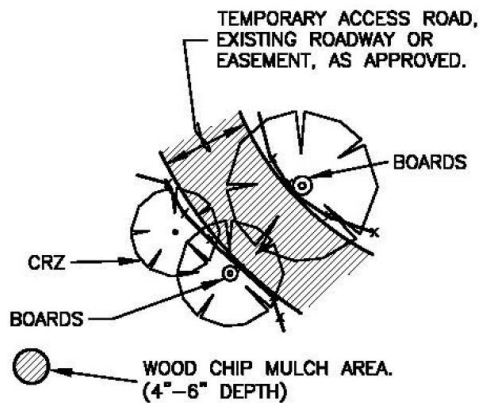

LINEAR CONSTRUCTION THROUGH TREES

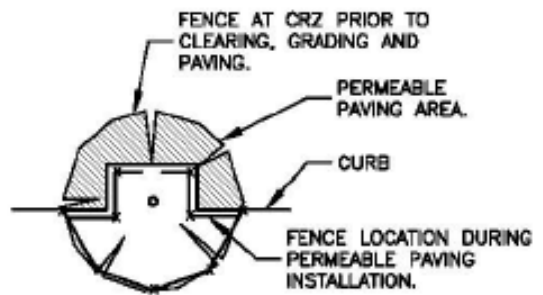

TREES IN PAVING AREA

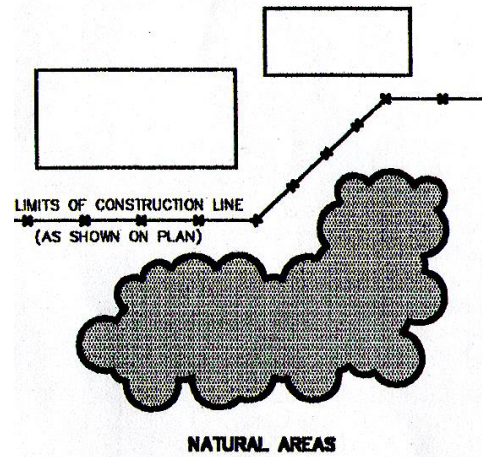

2. **Size and type of fence**

Chain link fences around protected trees shall be a minimum of five (5) feet high. Fences are to be mounted on two inch diameter galvanized iron posts, driven into the ground to a depth of at least 1-foot at no more than 10-foot spacing. This detail shall appear on grading, demolition and improvement plans.

3. **Duration**

Tree fencing shall be erected before demolition, grading, grubbing, or construction begins and remain in place until the certificate of occupancy has been granted. Removal of the fence during construction must be approved by the City Forester. ***Fence removal without the approval of the City Forester or Administrator will result in a stop work order.***

4. **'Warning' Sign**

A warning sign shall be prominently displayed on each fence. The sign shall be a minimum of 16 x 24 inches and clearly state:

WARNING
- Critical Root Zone –
Encroachment may result in
permanent tree damage, resulting
in tree replacement.

2.4. TREE PRUNING AND TREE SURGERY PRIOR TO CONSTRUCTION

Prior to construction, various trees may require that branches be pruned clear from structures, activities, building encroachment or may need to be strengthened by means of mechanical support or surgery per approval of the City Forester. All tree pruning and surgery shall be performed by or under the supervision of a Certified Arborist pursuant to the standards and techniques provided with Section 4.

2.5. ACTIVITIES DURING CONSTRUCTION & DEMOLITION NEAR TREES

Soil disturbance or other injurious and detrimental activity within the CRZ is prohibited unless approved by the City Forester or Administrator. If an injurious event inadvertently occurs, or soil disturbance has been specifically conditioned for project approval, then the following mitigation is required:

2.5.1. Soil compaction- If compaction of the soil occurs, it shall be mitigated as outlined in Section 2.5.5.

2.5.2. Grading limitations within the Critical Root Zone-

- Grade changes within the CRZ are not normally permitted.
- If grading within the CRZ is approved, grading shall be done by hand or with small equipment to minimize root damage.
- Grade changes outside the CRZ shall not significantly alter drainage to the tree
- Grade changes under specifically approved circumstances shall not allow more than six (6) inches of fill soil added or allow more than six (6) inches of existing soil to be removed from natural grade unless mitigated.
- Grade fills over six (6) inches or impervious overlay shall incorporate an approved permanent aeration system, permeable material or other approved mitigation.
- Grade cuts exceeding six (6) inches shall incorporate retaining walls or an appropriate transition equivalent.

Illustration 2-10: Options in tree preservation due to grade change

From: City of Austin

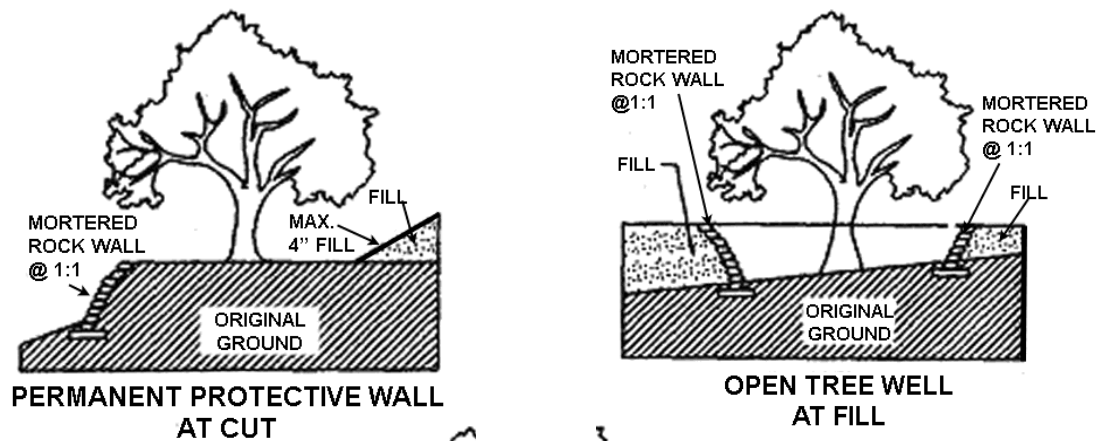

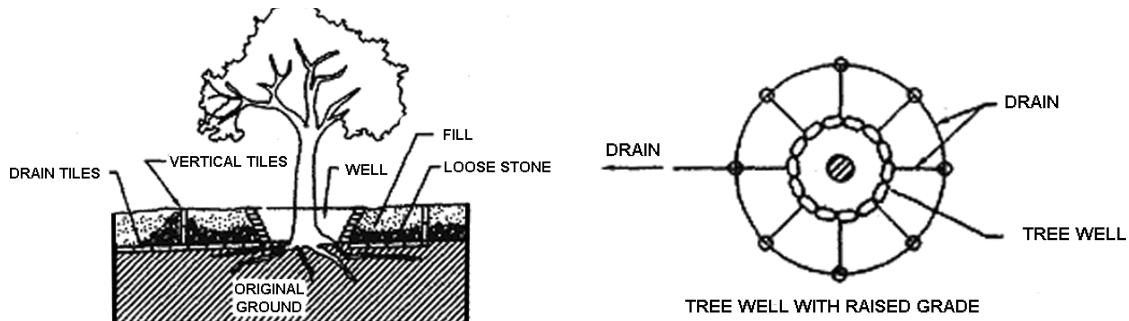

Illustration 2-11: Changing grade around tree trunk by grading or fill. Trees which have too high of a grade during or after construction will lack the root flare.

From: A Guide to Preserving Trees in Development Projects.

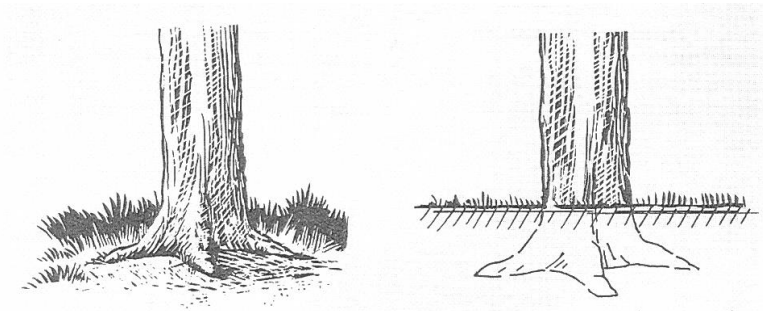
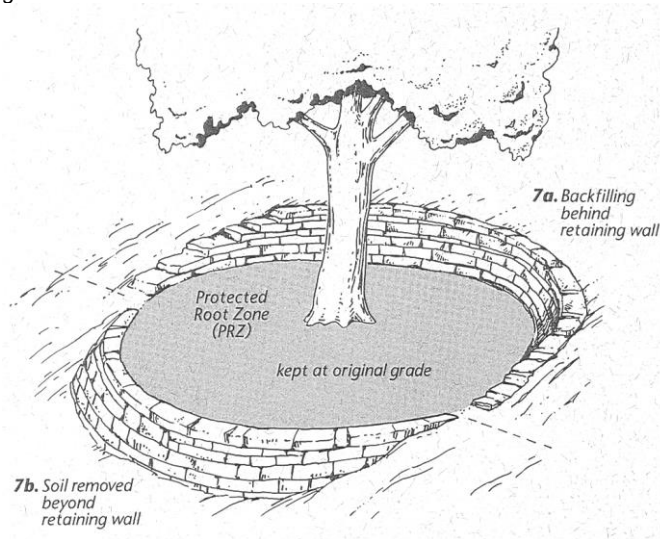

Illustration 2-12: Using retaining walls when natural grade must be raised or lowered.

From: Building Greener Neighborhoods.



2.5.3. Trenching, excavation and equipment use- Normally, trenching is allowed outside of the CRZ. Trenching, excavation or boring activity within the CRZ is restricted to the following activities, conditions and requirements if approved by the City Forester. Mitigating measures shall include prior notification to and direct supervision by the project arborist or landscape architect.

- a. Notification. Contractor shall notify the project arborist or landscape architect a minimum of 24 hours in advance of the activity in the CRZ. As noted above, the

project arborist or landscape architect must notify the City Forester or Administrator before any work begins in the CRZ.

- b. Root Severance. Roots that are encountered shall be pruned flush with the soil. Backfill root areas with good quality top soil within the same day. If exposed root areas are not backfilled within the same day, cover them with organic material in a manner which reduces soil temperatures and minimizes water loss due to evaporation.
- c. Excavation. Any approved excavation, demolition or extraction of material shall be performed with equipment sitting outside the CRZ. If approved by the City Forester, hand digging, hydraulic or pneumatic air excavation technology may occur within the CRZ provided the work is performed by or under the supervision of a certified arborist.

If excavation or trenching for drainage, utilities, irrigation lines, etc., it is the duty of the contractor to tunnel under any roots 2 inches in diameter and greater.

(Prior to excavation for foundation/footings/walls) If grading or trenching within the CRZ is approved by the City Forester,, the roots shall first be severed cleanly 1 foot outside the CRZ and to the depth of the future excavation. The trench must then be hand dug and roots pruned with a saw, narrow trencher with sharp blades or other approved root pruning equipment.

- d. Heavy Equipment. The use of backhoes, steel tread tractors, skid steer or any heavy vehicles within the CRZ is prohibited, unless approved by the City Forester. If allowed, a protective root buffer is required.
- e. Structural design. If injurious activity or interference with roots greater than 2-inches will occur within the CRZ, plans shall specify a design of special foundation, footing, walls, concrete slab or pavement designs subject to City Forester approval. Discontinuous foundations such as concrete pier and structural grade beam must maintain natural grade (not to exceed a 4-inch cut), to minimize root loss and allow the tree to use the existing soil. Basement excavations shall be designed outside the CRZ of all protected trees and shall not be harmful to other mature or neighboring property trees.

2.5.4. Tunneling and directional drilling- If tunneling or pipe installation has been approved within the CRZ, the trench shall be either cut by hand, air-spade, hydraulic vac-on excavation, or by mechanically boring the tunnel under the roots with a horizontal directional drill and hydraulic or pneumatic air excavation technology. In all cases, install the utility pipe immediately, backfill with soil and soak with water within the same day. Installation of private utility improvements shall be tunnel bored beneath the tree and roots pursuant to the following trenching limitations and boring requirements described in Illustration 2-14, Trenching Tunneling and Distances.

Emergency utility repairs shall be exempt from the above restriction zones within the CRZ. The City Forester shall be contacted after any such repairs that may result in significant tree damage or removal.

Illustration 2-14: Trenching and boring distances.

Illustration 2-13: Trenching and boring options illustrated.
From: Conserving Wooded Areas in Developing Communities

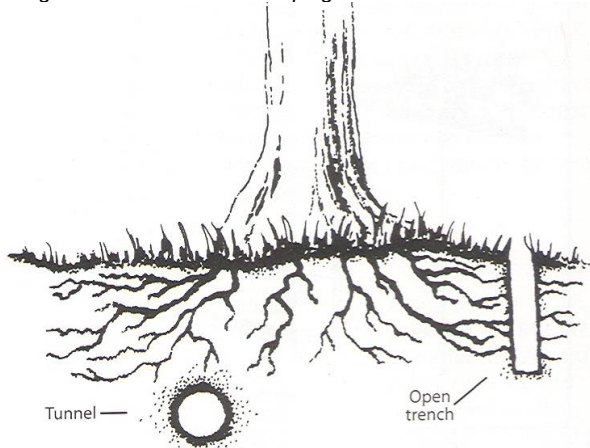

TRENCHING DISTANCE

↔ ↔

No trenching shall occur within the Critical Root Zone (CRZ) unless otherwise approved by the City. However, trenching shall not occur within 50% of the CRZ measured from the base of the tree or within 5 feet from the base of the tree. The Critical Root Zone (CRZ) shall be measured one foot of radial distance for every inch of tree Diameter at Breast Height (DBH). When trenching is not permitted, boring will be an acceptable alternative pursuant to the tunneling depth requirements based on the respective tree diameters (DBH) provided below.

DEPTH OF TUNNELING

⦿ ⦿

Tree DBH	Depth of Tunneling within the CRZ
9" or less	2.5'
10-14"	3'
15-19"	3.5'
More than 19"	4.0'

2.5.5. Construction impact mitigation- A mitigation program is required if the approved development will cause drought stress, dust accumulation, soil compaction to trees that are to be saved or construction (including trenching) is permitted within the CRZ. To help reduce impact injury, one or more of the following mitigation measures shall be implemented and supervised by the project arborist or landscape architect as follows:

- a. Irrigation program- Irrigate or water once every two weeks with 10 gallons of water per diameter inch within the CRZ until project completion. Irrigation may be suspended when normal rainfall equals the required application rate within 10 days of the required application. The owner or general contractor shall select a watering or irrigation contractor. The signed contract shall be provided to the City prior to the approval of the Tree Protection and Preservation Plan (Section 2.3).

- b. Dust control program- During periods of extended drought, wind or grading, spray water on the trunk, limbs and foliage to remove accumulated construction dust.
- c. Soil compaction damage- Compaction of the soil is the largest killer of trees on construction sites due to suffocation of roots and ensuing decline of tree health. If compaction occurs to the upper 12-inches of soil within the CRZ by any means, then one or more of the following mitigation measures shall be implemented.
 - i. Type I Mitigation. If an approved paving, hardscape or other compromising material encroaches within the CRZ, an aeration system shall be designed by the project arborist or landscape architect and used within this area (subject to approval by the City Forester).
 - ii. Type II Mitigation. If inadvertent compaction of the soil has occurred within the CRZ, the soil shall be loosened by one or more of the following methods to promote favorable root conditions: vertical mulching, soil fracturing, core-venting, radial trenching or other method approved by the City Forester.

2.6. DAMAGE TO TREES

2.6.1. Reporting- Any damage or injury to trees shall be reported the same day to the project arborist, landscape architect, job superintendent and City Forester so that mitigation can take place. All mechanical or chemical injury to branches, trunk or roots over 2 inches in diameter shall be reported. In the event of injury, the following mitigation and damage control measures shall apply:

- a. Root injury: If trenches are cut and tree roots 2 inches or larger are encountered they must be cleanly cut back to a sound wood lateral root. The end of the root shall be sawed off with a clean cut. All exposed root areas within the CRZ shall be backfilled or covered the same day. Exposed roots may be kept from drying out by temporarily covering the roots and draping layered burlap or carpeting over the upper 3 feet of trench walls. The materials must be kept wet until backfilled to reduce evaporation from the trench walls.
- b. Bark or trunk wounding: Current bark tracing and treatment methods shall be performed by or under the supervision of a certified arborist within two days.
- c. Scaffold branch or leaf canopy injury: Remove by clean cutting broken or torn branches back to an appropriate branch capable of resuming terminal growth within five days. If leaves are heat scorched from equipment exhaust pipes, consult the project arborist or landscape architect the same day.

2.6.2. Penalty for damage to protected trees- In the event that protected trees or their roots have been damaged, replacement shall be required if the City Forester deems that the trees are irreparable harm and need to be replaced. Damaged trees will be replaced according to Subchapter 12 of the Unified Development Code.

2.7. PAVEMENT AND HARDSCAPE CONFLICTS WITH TREE ROOTS

Conflicts may occur when tree roots grow adjacent to paving, foundations, sidewalks or curbs (hardscape). Improper or careless extraction of these elements can cause severe injury to the roots and instability or even death of the trees. The following alternatives must first be considered before root pruning within the CRZ of a protected tree.

2.7.1. Removal and replacement of pavement or sidewalk:

- a. Removal of existing pavement over tree roots shall include the following precautions: Break hardscape into manageable pieces with a jackhammer or pick and hand load the pieces onto a loader. The loader must remain on undisturbed pavement or off exposed roots. Do not remove base rock that has been exploited by established absorbing roots. Apply untreated wood chips over the exposed area within one hour, then wet the chips and base rock and keep moist until overlay surface is applied.
- b. Replacement of pavement or sidewalk: An alternative to the severance of roots greater than 2 inches in diameter should be considered before cutting roots. If an alternative is not feasible, remove the sidewalk and grind roots only as approved by the City Forester. Use a wire mesh reinforcement if within 10 feet of the trunk of a protected tree.

2.7.2. Alternative methods to prevent root cutting (Recommended):

The following remedies should be considered before cutting tree roots that may result in tree instability or decline:

- a. Grinding a raised sidewalk edge.
- b. Ramping the walking surface over the roots or lifted slab with pliable paving.
- c. Routing the sidewalk around the tree roots.
- d. Flexible paving or rubberized sections.
- e. On private property, new sidewalk or driveway design should offer alternatives to conventional pavement and sidewalk materials. Substitute permeable materials for typical asphalt or concrete overlay, sub-base or footings to consider are: permeable paving materials, interlocking pavers, flexible paving, wooden walkways, porches elevated on posts and brick or flagstone walkways on sand foundations.

2.7.3. Avoiding conflict (Recommended)

Conflicts and associated costs can be avoided or reduced by the following planting practices:

- Plant deep rooted trees that are proven to be non-invasive.
- Over soil that shrinks and swells, install a sidewalk with higher strength that has wire mesh and/or expansion slip joint dowel reinforcement.
- Follow soil loosening planting techniques to promote deep rooting.
- Install root barrier only along the hardscape area of the tree (but allow roots to use open lawn or planter strip areas).

2.7.4. Alternative base course materials (Recommended)

When designing hardscape areas near trees, the project architect or engineer should consider the use of recommended base course material such as an engineered structural soil mix. Structural soil mix will allow a long term cost effective tree and infrastructure compatibility that is particularly suited for the following types of development projects: repair or replacement of sidewalk greater than 40 feet in length; subdivisions with new street tree plantings; planting areas that are designed over structures or parking garages; confined parking lot median and islands or other specialized conditions as warranted.

SECTION 3: TREE REMOVAL, REPLACEMENT, PLANTING, AND MAINTENANCE STANDARDS

3.1. INTRODUCTION

A protected tree may not be removed without City review and approval, except in certain emergencies. The purpose of City review is to verify that the removal is allowed under the Ordinance, and to prevent unnecessary tree removal. This section discusses conditions for tree removal, replacement of protected trees, planting and pruning of replacement trees and maintenance.

3.2. TREE REMOVAL

3.2.1. Allowable removal- Tree removal is approved as part of the subdivision construction, site disturbance (grading) and site plan processes. Site disturbance permit allows for tree removal and/or grading. These three processes are defined in the Ordinance. **Before removing a protected tree, regardless of the condition of the tree, a subdivision construction plan, site disturbance or a site development permit must be approved by the City.**





3.2.2. Protected Tree Removal (Site Disturbance) Permit Application- Site Disturbance Permit applications (allowing for tree removal) are available at the City of Pflugerville Planning Department.

3.3. TREE REPLACEMENT PLAN

Replacement requirements are defined in Subchapter 12, and are limited to protected trees. It is important to note that tree replacements during the site plan process will be addressed in both the Tree Preservation Ordinance (Subchapter 12) and the Landscape Ordinance (Subchapter 11). In selecting trees to be replaced, the types of trees removed will be replaced with the same or similar species. Illustration 3-1 shows the type of information required on a tree replacement plan.

The Tree Replacement Plan will include four elements: 1) a table including the common and Latin name; tree size in caliper inches, height, and spread; tree symbols; and quantity; 2) a tree planting plan (may be combined with the Landscape Plan); 3) proper tree planting details including planting hole, tree planting, staking, and mulching; 4) notes on proper tree planting as described in section 3.7 of this Manual. Illustration 3-1 shows the type of information required on a tree replacement plan.

Illustration 3-1: Tree Replacement Plan

Symbol	# of trees	Species	Caliper Size	Height	Spread
	2	Cedar Elm <i>Ulmus crassifolia</i>	3" caliper	10'-12' high	5' spread
	5	Chinquapin Oak <i>Quercus muehlenbergii</i>	3" caliper	10'-12' high	5' spread
	1	Pecan <i>Carya illinoensis</i>	3" caliper	10'-12' high	5' spread
	3	Live Oak <i>Quercus virginiana (fusiformis)</i>	3" caliper	10'-12' high	5' spread
Required Replacement: 63 inches Total replacement on site: 11 trees @ 3" cal. = 33 inches Tree Fee in-lieu: 30 diameter inches remaining x \$150 per diameter inch = \$4,500 to Tree Fund					

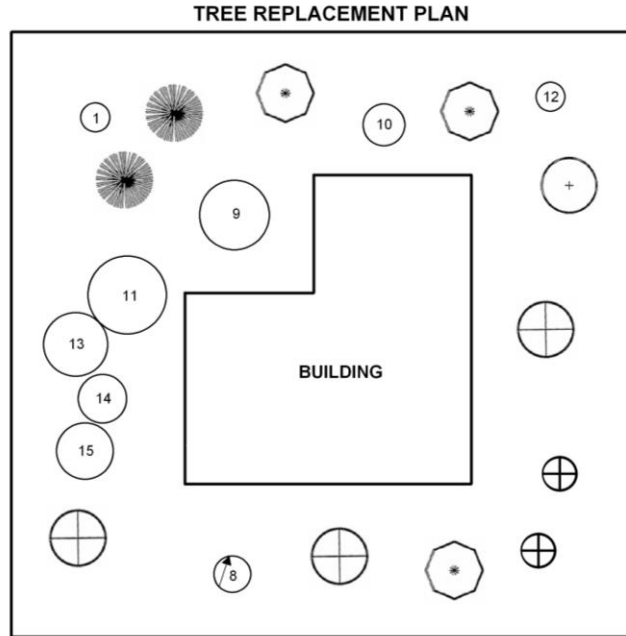

3.4. TREE PLANTING REQUIREMENTS

3.4.1. Species- The replacement trees shall be the same or similar species, unless the City Forester or Administrator determines that another species would be more suitable for the location or if there is a need to promote diversity of species. Factors to be considered include the long term health of the tree in the location and its compatibility with adjacent uses, as well as design considerations.

The Tree Replacement Plans shall be designed to avoid creating monocultures, or areas of plantings made up of only one species of trees. Monocultures are undesirable because if a certain species is prone to a particular disease or is more susceptible to storm damage or temperature extremes, then it is likely the entire stand could die or be destroyed by a single disease or weather event. Creating planting areas of several species creates a more diverse, and therefore more resistant, urban forest.

Hackberry, Chinese Tallow, Chinaberry, Mulberry, Arizona Ash, Cottonwood, Poplar, Silver Maple, Mimosa, American Sycamore and Willow trees shall not be planted along city streets due to damaging surface roots and the possibility of causing damage to sidewalks, utilities and curbs. These trees also have short lifespans, weak wood, and susceptibility to disease and insects.

With the exceptions noted above, other species shall be chosen from the Approved Tree List: Subchapter 11, Table 11.11.3.

3.4.2. Planting distances/spacing requirements:

- a. Minimum distance between newly planted trees (Recommended):

Tree Spacing			
Tree Size	Small	Medium	Large
Small	20 feet	25 feet	20 feet
Medium	25 feet	30 feet	30 feet
Large	20 feet	30 feet	40 feet

- b. Minimum distance from any underground utility, water meter boxes, and fire hydrant: 5 feet
- c. Minimum distance from trees to curb, sidewalk, or driveway: 4 feet
- d. Planting strips shall be a minimum of 8.5 feet wide.
- e. Minimum distance from buildings and similar structures (Recommended):
Large size tree: 30 feet;
Medium size tree: 20 feet; and,
Small size tree: 10 feet.
- f. Recommended minimum distance from overhead utility lines. Trees cannot be planted under utility lines. In order to avoid future interference of limbs, planting may take place as follows:
Large trees: 30 feet from line;
Medium trees: 20 feet from line; and
Small trees: 10 feet from line.
- g. From curb line of an intersection: 30 feet, which is subject to visibility triangles.
- h. Minimum distance from stop or yield signs: 20 feet.
- i. Distance from directional traffic sign: 10 feet.
- j. Distance from street lights: 25 feet for large or medium tree, 15 feet for small tree.

Variations from the requirements listed above shall be approved by the City Forester.

3.5. TREE STOCK AND MATERIALS

3.5.1. Quality- It is the contractor’s responsibility to supply tree stock that meets standards addressed in this Manual.

- All trees and plant material installed within the City of Pflugerville shall conform to the *American Standard for Nursery Stock* ANSI Z60.1 - 2004.
- Trees shall be sound, healthy, vigorous, and free of plant disease and insect pests or other damage.
- Container grown trees shall be grown for at least 8 months in containers in which delivered and shall not be root bound or have girdling roots. The root ball will be moist and the roots will be contained within the container.
- Trees shall not have been topped or headed.

- The tree will have healthy leaves if it is the time of year for trees to have leaves.
- There will be no weeds growing out of the container.
- If the tree is multi-stemmed, the stems will not be squeezing against each other or the trunk of the tree.
- Trees with broken tops, branches, injured trunks, poor structure, low branching, poor vigor, and apparent poor quality shall be rejected; the City Forester or Administrator has the right to reject trees that do not meet the quality standards.

3.5.2 Container grown/ball and burlapped trees- From April 1-September 30, only container grown trees will be planted. From October 1-March 31, either container grown or ball and burlapped (B&B) trees may be planted.

Recommendation: It is recommended that container grown trees be used all year.

3.5.3 Miscellaneous materials- The following materials shall be used unless otherwise specified:

- Tree stakes. Metal T-posts shall be used.
- Tree Ties. Tree ties may include one of two types. The first is a 10 gauge wire, cushioned with a rubber hose around the trunk. The wire should not touch the trunk. The second is a plastic chain lock, also called twist brace.
- Mulch. All newly planted trees should be mulched with 2-4 inches of organic mulch. Mulch should never be placed against the trunk of a tree. There should be a space of 1-2 inches between the trunk and mulch where the root flare is visible. Mulch should cover the entire tree planting hole.
- Root Control Barriers. Use along all public sidewalks, and indicate on approved plans and drawings.
- Tree guards. For trees in turf areas requiring regular mowing and/or weed eating, the tree trunk shall be protected with TreeGuard or equivalent.
- Tree grates. Where sidewalk width is less than 8 feet and new trees will be installed in a tree well, metal tree grates may be used and approved by the DRC. Minimum size grates shall be minimum 4' x 4' unless specified otherwise. All tree grates shall be mounted in frames, inset into a concrete foundation within the sidewalk or surface material, and shall be flush with the surrounding surface.

3.6. PLANTING SITE PREPARATION

3.6.1. Soil preparation and conditioning- All debris, wood chips, pavement, concrete and rocks over 2 inches in diameter shall be removed from the planting pit to a minimum of 24-inch depth and a width in accordance with the minimum planting requirements established in Subchapter 11, Table 11.11.3, unless specified otherwise.

3.6.2. Planter pit preparation

- *Trees in a confined planter pit or sidewalk area:* The planting hole shall be excavated to a minimum of 30 inches deep x the width of the exposed area. Scarify the sides of the pit. Soil beneath the root ball shall be compacted to prevent settling.
- *Trees in all other areas:*
 - a. Mark out a planting area 2 to 3 times wider than the rootball diameter (the wider the better). Loosen this area to about an 8" depth. This will enable your tree to extend a dense mat of tiny roots well out into the soil in the first one to ten weeks in the ground.

- b.** Excavate the hole's width a minimum of two times the diameter of the container, and deep enough to allow the root ball of the container to rest on firm soil with the top of the root ball even with the grade. Scarify the sides and the bottom of the pit.

3.6.3 Drainage

Adequate drainage must be provided to the surrounding soil for the planting of new trees. If the trees are to be planted in impermeable or infertile soil, and water infiltration rates are less than two (2) inches an hour, then one of the following drainage systems or other approved measures must be implemented:

- French drain, a minimum of three (3) feet in depth
- Drain tiles or lines beneath the trees
- Auger six drain holes at the bottom perimeter of the planting pit, at a minimum of four (4) inches in diameter, twenty-four (24) inches deep and filled with medium sand or fine gravel

3.7. PLANTING THE TREE

After the hole has been prepared as described in Section 3.6 above, the tree is ready to be planted.

3.7.1. Container grown tree

Pull the container away from the root ball. Don't pull the tree out by its trunk. Container-grown trees often have circling or girdling roots running along the edge of the root ball. If they exist in this area, cut them and spread them apart. Place the root ball in the center of the hole and adjust the tree so it is straight and at the proper level. Make any adjustments prior to filling the hole with dirt.

3.7.2. Ball and burlapped tree

Rest the root ball in the center of the hole, and reshape the hole so the tree will be straight and at the proper level. After adjusting the tree, pull the burlap and any other material away from the sides and top of the root ball. Do not remove the burlap from the bottom. If you adjust or lift the tree after the burlap has been removed you run the risk of damaging the root system.

Illustration 3-2: Tree planting detail graphic

From: City of Round Rock

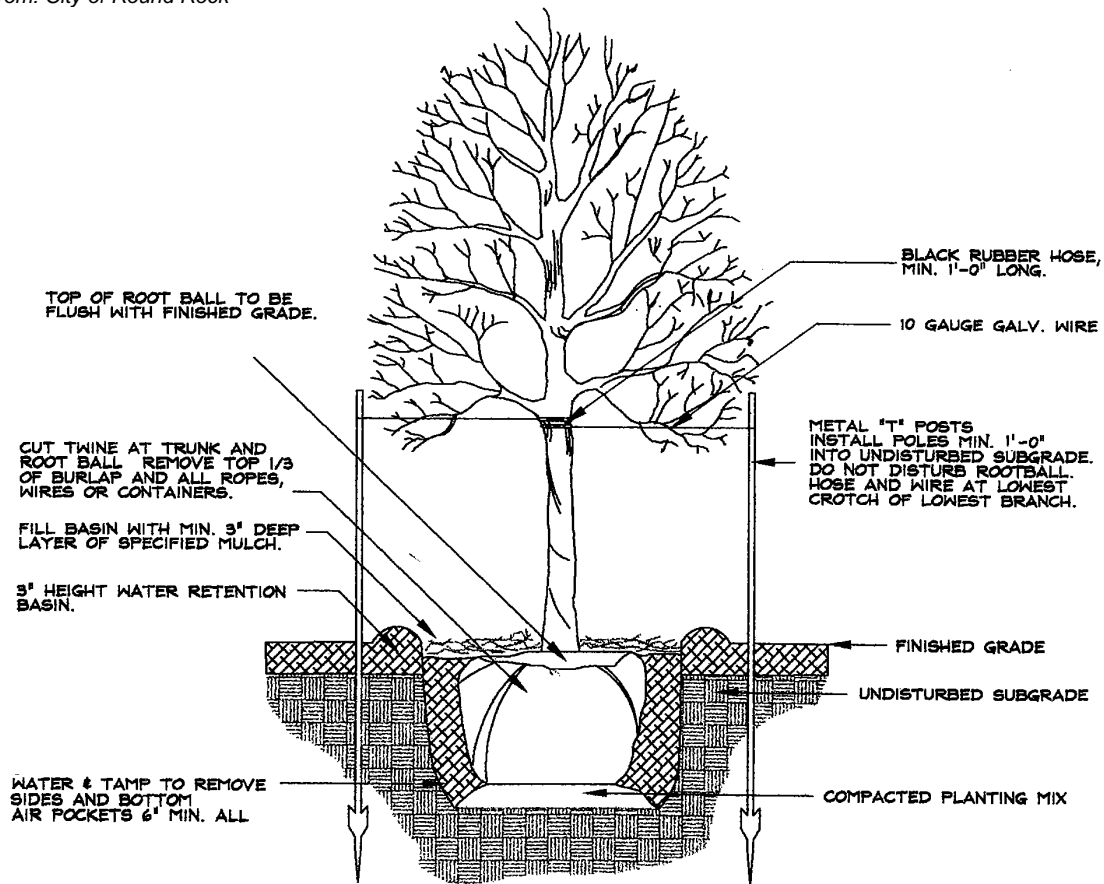

3.7.3. Backfill soil, amended soil

Backfill with the original soil, unless the original soil has been removed or the soil is poor. If soil must be amended, consult with a landscape architect or certified arborist in identifying the most appropriate soil mix.

3.7.4. Filling the hole

Fill until the hole is half full. Flood the hole with a slow hose or tamp gently with your foot to firm the soil. Repeat until the hole is full. Do not press too firmly—only firm enough to hold the tree upright. Backfilling with soil and water or gently tamping will remove large air pockets.

3.7.5. Constructing a berm or dam

Construct a small dam or berm three (3) feet in diameter around the tree. The berm should be approximately three (3) inches high.

3.7.6. Mulching

Cover the entire loosened area of soil with 2 to 4 inches of mulch composed of shredded wood or bark in the entire planting area. Mulch will be placed one to two inches away from the trunk of the tree. The root flare shall be visible after mulching.

3.7.7. Staking or guying

Bamboo stakes, if any, will be removed. Staking or guying is to prevent movement of the lower trunk and root system. Movement of the top is desirable and will strengthen the tree. The stakes will be installed 12-18 inches in undisturbed soil outside of the planting

hole. Depending on height and size of the tree, stakes shall be six, eight, or ten feet tall. Trees shall be staked with 3 metal T-posts. Metal stakes will not rub against tree trunks. Tree ties will be located near the lowest main branch on the tree. Check a staked or guyed tree monthly during the growing season and after storms or strong wind. The system will be snug, but not to the point of making an impression on the stem or trunk. If that happens, loosen the tie or wire around the trunk. Do not stake a tree any longer than necessary. One or two growing seasons is all that is needed.

Illustration 3-2 and 3-3 show the proper staking and guying techniques. In Illustration 3-3 A, trees 3-4 inches in diameter are supported by three stakes. Branches should not rub against the stakes. For trees over four (4) inches, guy wires should be used, with a minimum of three guys. Cable or wire is attached to the tree by running wires through a piece of hose or by using lag hooks on large trees. The guys should be secured to arrowhead-shaped land anchors (C), wooden stakes (D), or deadmen buried in the soil (E).

Illustration 3-3: Staking and Guying Trees
From: Principles and Practice of Planting Trees and Shrubs

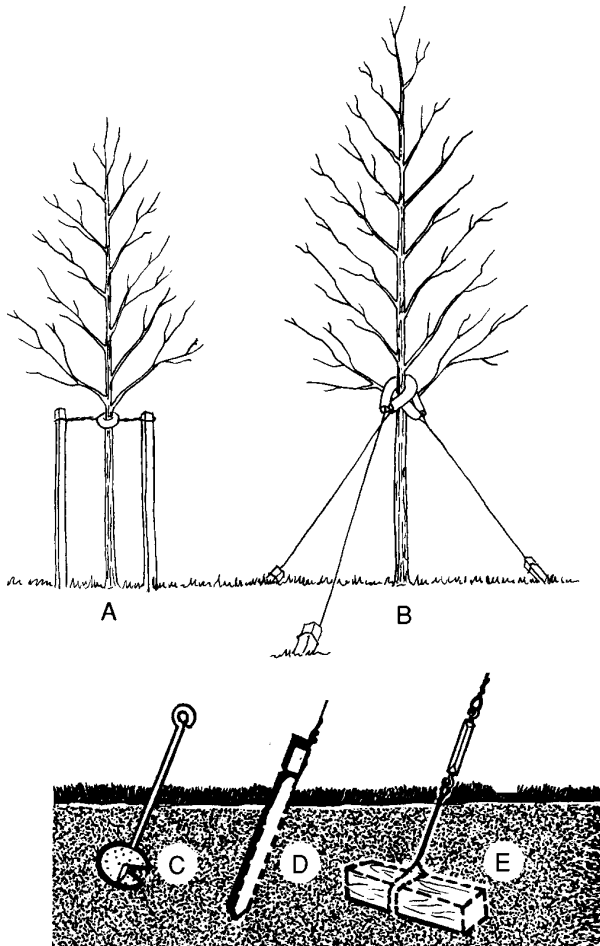

3.8. TRANSPLANTING TREES

3.8.1. *General*

Transplanting large trees is difficult, expensive, and requires expertise and equipment. Pre-approval from the City Forester and periodic inspections will be required for the transplanting of a protected tree. Such trees will be under warranty as if it is a new tree, and will need to follow replacement requirements should the tree die or severely decline. When transplanting protected trees eight (8) inches and larger from existing landscapes it is important to select healthy, vigorous trees, dig an appropriate size root ball, select a site that is consistent with the tree's cultural needs, provide a saucer shaped planting hole approximately three times the root ball width, and then protect the root ball, trunk, and crown during lifting, transportation, and storage. The most important and hardest part in tree transplanting is creating and implementing a multi-year aftercare program, providing adequate moisture to the root ball.

When a tree is dug for transplanting, as much as 90% of its root system is left behind, severed in the process of digging for transplanting. The tree has a hard time relying on 5-10 percent of its root system doing the work of the 90 percent that was lost. Until it is well established, the root system will have difficulty supplying enough water to the leaves. This stress impacts vigor of the tree and also exposes the tree to the risk of being vulnerable to pests and diseases, as well as less able to adapt to or withstand drought, extreme cold, and drying winds.

3.8.2. *Considerations*

The following issues should assist in providing a successful transplanting. Considering the size of the protected trees being transplanted, a professional arborist is required to assist in the process.

- **Site-** Before transplanting make sure the tree is a good match for the new site.
- **Timing-** Recommended timing for transplanting trees is during the dormant season, when the tree is not trying to support its leafy crown.
- **Health of tree-** Select a tree that is in good health and shape and has no major defects in its trunk branch structure.
- **Success rate-** Different species have different success rates in transplanting. Consult with your certified arborist on the success rate of the tree you want to transplant.
- **Tree size-** Most commonly transplanted trees range in size from 5-15 diameter inches.

3.8.2. *Transplanting process-*

a. *Digging up the tree-*

- Dig up a wide root ball with appropriate depth and wrap burlap material with wire and twine to save as much of root ball as you can intact.
- A rule of thumb for trees over six inches in diameter is that a root ball = 10 inches in diameter for every tree trunk diameter measured at 4 ½ feet above the ground (see Chapter 2 for a discussion on measuring the tree diameter in unusual situations). In other words, a 10-inch tree should have a 100 inch diameter. Likewise, the ball depth should be about 60% of the ball diameter. The same 10-inch tree should have a 60 inch depth.
- While smaller trees can be transplanted using a tree spade or other specialty equipment/techniques, larger trees will require mechanical

digging equipment and appropriate hoists and heavy equipment for moving the tree.

b. Transporting the tree-

During transportation the tree crown should always be covered with tarp to protect the tree from drying out and windburn.

c. After transplanting-

- Keep the root ball moist at all times. Anticipate watering three times a week, or in very hot weather every day. Continued watering will be required for several years.
- **Do not prune newly transplanted trees to reduce crown and compensate for root loss. That will only further weaken the tree.**
- Mulch the transplanted tree with 2-4 inches of organic mulch to cover root ball.
- The process of regenerating a normal root system will take several years, especially for large trees. Immediately after transplanting, the tree will be susceptible to extreme stress. Moisture is a critical factor in new root growth. Compacted soils and soil temperature also impact the growth of roots.

(Abridged from “Transplanting Trees”, by Patrice Peltier and Gary W. Watson. *Arbor Age*, January-March 2000.)

3.9. IRRIGATION PLAN

The City of Pflugerville promotes water conservation by:

- Requiring native and adapted tree species (See Approved Tree List: Subchapter 11, Table 11.11.3).
- Requiring irrigation zones to be grouped by water requirements of plants.
- Requiring bubblers for new trees.
- Promoting gray water recycling systems and cisterns to supplement irrigation systems.
- Providing a recommended watering schedule for new tree establishment:
 - Irrigation frequency and amount depend on several factors including the size of the rootball, season, tree species, soil infiltration rate, drainage, slope, and rainfall.
 - Generally, a newly planted tree requires 2 gallons of water per caliper inch at each watering event. A 3” caliper tree would require 6 gallons of water per watering event.
 - A newly planted 3” caliper tree requires water:
 - Daily for two weeks (may omit if planting between November and March)
 - Every other day for 4 months
 - Weekly for the remainder of the year
 - Once every two weeks the following year
 - Once a month the third year and or as needed if droughty
 - If the tree has been successfully established during the first three years, the water absorbing roots will be far beyond the drip emitters and those zones can be turned off.

Irrigation Plan Notes: The following requirements are mandatory for all irrigation plans and are in addition to any applicable notes referenced in Chapter 113, Irrigators.

1. An automatic irrigation system shall be installed. All automatic irrigation systems shall be equipped with an electronic controller capable of dual or multiple programming.

2. Controller(s) shall have multiple cycle start capacity and a flexible calendar program, including the capability of being set to water every five days.
3. All automatic irrigation systems shall be equipped with a rain and freeze sensor shut-off device.
4. The irrigation system must be designed by a licensed irrigator.
5. Irrigated turf grass area is limited to 33% of the total landscape area provided.
6. A minimum of one (1) bubbler shall be provided for all newly planted trees. Trees larger than 3 inches in caliper shall have two (2) bubblers. The bubbler(s) shall be installed at each tree, located 12-18 inches from the trunk, and shall operate on valves separate from the spray zones. Tree irrigation zones shall not share the same irrigation zones, including valves and circuits, as shrubs and plants due to different watering requirements.
7. No trenching or boring shall occur within the tree protection fencing or CRZ without prior approval from the City Forester.
8. Irrigation shall be design and installed in accordance with Subchapter 11 of the Unified Development Code and Chapter 113: Irrigators.
9. Irrigation plans shall be submitted and approved prior to irrigation installation and final site inspection.

3.10 MAINTENANCE

All newly planted trees shall be maintained by the owner pursuant to Section 4. Maintenance practices shall consist of all regular and normal maintenance of trees, including but not limited to irrigation, pruning, stake adjustment and removal, and disease control. Plant material that exhibits severe levels of insect or pest infestation, disease and/or damage, shall be appropriately treated, and all dead trees shall be removed and replaced with living trees where required according to the city approved Tree Replacement Plan or Site Plan for the site.

SECTION 4: TREE PRUNING, SURGERY, AND MAINTENANCE

4.1. GENERAL TREE PRUNING AND TREE SURGERY

4.1.1. *Pruning:*

The most compelling reason to prune is to develop a strong, safe framework and tree structure. Heavy pruning just after the spring growth flush shall be avoided. This is when trees have just expended a great deal of energy to produce foliage and early shoot growth. Removal of a large percentage of foliage at this time can stress the tree. Pruning may be performed provided it is conducted pursuant to standards provided herein, and the tree's natural shape is preserved.

4.1.2. *Certified Arborist Required:*

All tree pruning and surgery shall be performed by or under the supervision of a Certified Arborist pursuant to the standards and techniques provided herein. For all properties exempt from the tree preservation standards of Subchapter 12 of the Unified Development Code, the pruning and maintenance standards provided within the section shall serve as best management practices.

4.1.3. *Time of Year for Pruning:*

All trees except oaks (Recommended):

- a. Most routine pruning to remove weak, diseased, or dead limbs can be accomplished at any time during the year with little effect on the tree. As a rule, growth is maximized and wound closure is fastest if pruning takes place between November and February, the dormant period for Central Texas trees.

Oak trees:

- b. Due to oak wilt disease, avoid pruning of all oak species between February and June. Clean cutting tools with a disinfectant between each tree pruned. Tree pruning paint shall be used on all pruning cuts on all oak species regardless of the time of year of pruning.

4.1.4. *Pruning limitations:*

- a. **Minimum pruning-** If the project arborist or landscape architect recommends that trees be pruned, and the type of pruning is left unspecified, the standard pruning shall consist of 'crown cleaning' only, as described below in Section 4.1.5. Trees shall be pruned to reduce hazards and develop a strong, safe framework.
- b. **Maximum Pruning-** Proceed with caution. Maximum pruning by thinning, raising or reduction of canopy shall only occur in the rarest situation and shall be approved by the City Forester. Provided that the Two Thirds - Live Crown Ratio is maintained for medium to large canopy trees (Type A and B trees per Subchapter 11), no more than one fourth (25 percent) of the functioning leaf and stem area may be removed within one calendar year of any protected tree. It must be recognized that trees are individual in form and structure, and that pruning needs may not always fit strict rules, whereby deviation from the standards may be approved by the City Forester.

4.1.5 Types of pruning:

Illustration 4-3: Types of crown pruning

From: *International Society of Arboriculture*

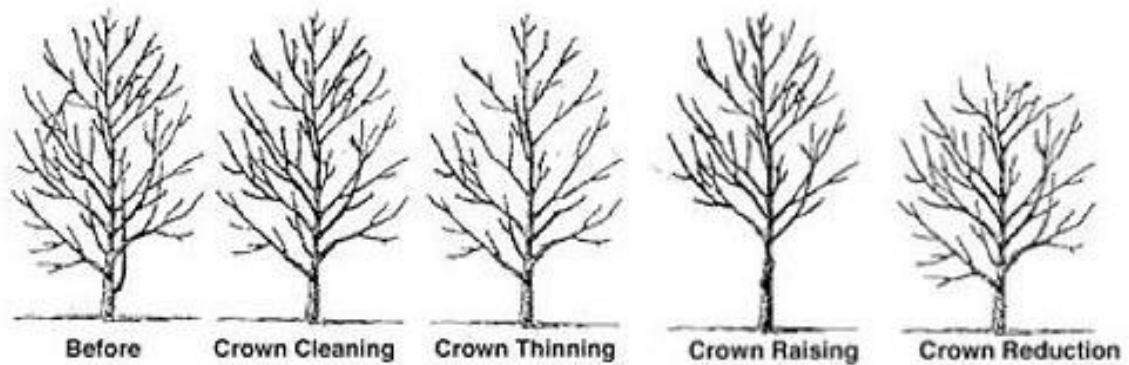

- a. **Cleaning:** The removal of dead, dying, diseased, weakly attached and low-vigor branches from the crown of a tree.
- b. **Thinning:** The selective removal of smaller crowded (less than two inch diameter) branches, evenly throughout the crown by a maximum of 25% of the total tree foliage, in order to increase light penetration and air movement through the crown. Thinning opens the foliage of a tree, reduces weight on heavy limbs and helps retain the tree's natural shape. (Thinning shall not be used for vision clearance of private site signage.)



Image – Left:

Thinning removes relatively small branches in the upper/outer tree canopy.

Thinning does NOT remove large branches, creating a gap in the tree canopy or affect the tree's shape, size or appearance.

c. **Raising:** Removes the lower branches from a tree in order to provide clearance for buildings, vehicles, pedestrians and vistas. Raising should be done gradually over a period of time. (Raising shall not be used for vision clearance of private site signage.) (Also known as 'limbing up') Crown raising shall be limited to:

- Removal of relatively smaller limbs (preferred cut diameter is less than two to four inches);
- Removal of only a few branches at one time, gradually over a period of time;
- Removal of branch does not exceed $\frac{1}{2}$ the size of the diameter of the trunk; and
- Crown raising does not remove more than $\frac{1}{3}$ of the tree crown and $\frac{2}{3}$ of the tree crown is maintained. (Measurement shall be total height of tree, prior to any pruning, divided into thirds. Crown raising may only occur within the bottom third of the tree.)
- When removing lower branches, maintain at least one-half of the foliage in the lower two-thirds of the tree. The lowest branch should be in the bottom 40% of the tree's height.

Illustration 4-2: Two Thirds - Live Crown Ratio

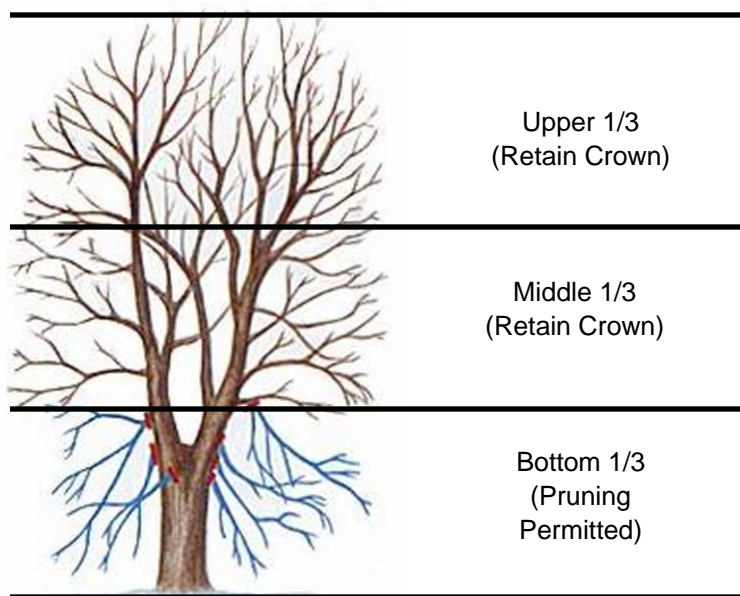

From: U.S. Department of Agriculture

d. **Reduction:** Reduces the size of a tree, often for clearance for utility lines, by the selective shortening or removal of branches, by a maximum of 25% of the total tree foliage. Reducing the height or spread of a tree is best accomplished by pruning back the leaders and branch terminals to secondary lateral branches that are large enough to assume the terminal roles (at least $\frac{1}{3}$ the diameter of the cut stem). Compared to topping, this helps maintain the form and structural integrity of the tree. (Reduction shall not be used for vision clearance of private site signage.)

4.1.6 Types of Pruning Prohibited

Tree topping or pollarding is prohibited and shall result in tree replacement or mitigation. Tree topping is the indiscriminate cutting of tree branches to stubs or to lateral branches that are not large enough to assume a terminal role. Other names include “heading”, “tipping”, “hat-racking”, and “rounding over.”

Illustration 4-4: Pruning Prohibited

From: International Society of Arboriculture

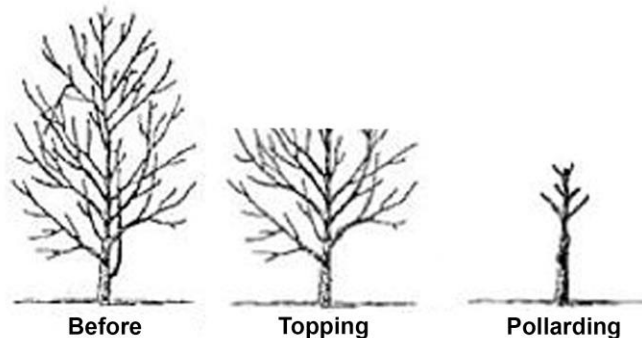

4.1.7 Making Proper Pruning Cuts

- a. Stub cuts are prohibited.
- b. Cuts will be made just beyond the outer edge of the collar of live wood. See Illustration 4-5 for an example.
- c. Don't use pruning paint or so called wound dressings, except for tree pruning cuts on all oak species at all times due to the threat of oak wilt disease.
- d. If a large limb is to be removed, its weight should first be reduced. This is done by making an undercut about 12-18 inches from the limb's point of attachment. A second cut is made from the top, directly above or a few inches further out on the limb. This removes the limb leaving the 12-18 inch stub. The stub is removed by cutting back to the branch collar. This technique reduces the possibility of tearing the bark. See Illustration 4-5 for an example.

Illustration 4-5: Proper tree cuts

From: International Society of Arboriculture

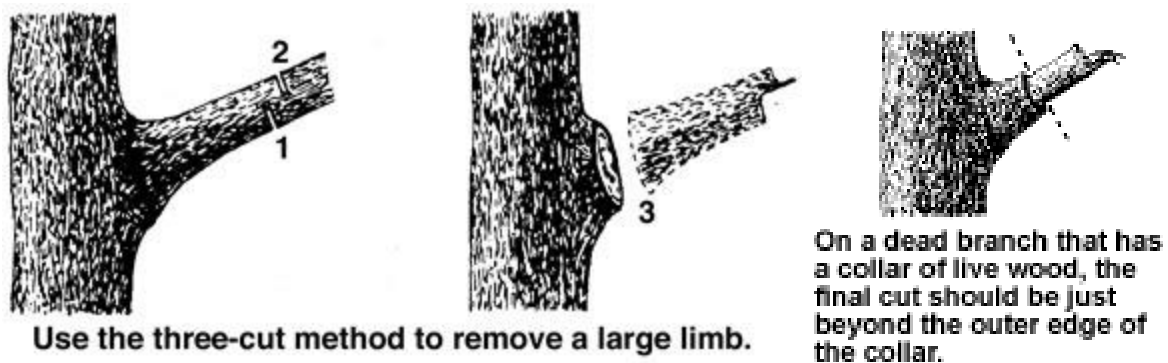

4.1.8. Tree Surgery

If it is necessary to promote health and prolong useful life or the structural characteristics, trees shall be provided the appropriate treatments (e.g. cavity screening, bark tracing, wound treatment, cables, rods or pole supports) as specified by the project arborist.

4.1.9 Tree Removal Adjacent to Protected Trees- When trees are removed and adjacent trees must be protected (as shown on the approved site plans), then the following tree removal practices apply:

- a. **Tree Removal-** Removal of trees that extend into the branches or roots of protected trees shall not be performed by demolition or construction personnel, grading or other heavy equipment. A certified arborist or tree worker under the supervision of a certified arborist shall remove the tree carefully in a manner that causes no damage above or below ground to trees that remain. After the removal of the tree, the certified arborist shall provide the City with a concurrence letter certifying the work performed was supervised and followed all requirements of the Tree Technical Manual, as applicable.
- b. **Stump Removal-** Before performing stump extraction, the project arborist shall first consider whether or not roots may be entangled with trees that are to remain. If so, these stumps shall have their roots severed before extracting the stump. Removal shall include the grinding of stump and roots to a minimum depth of 24 inches but expose soil beneath stump to provide drainage. In sidewalk or small planter areas to be replanted with a new tree, the entire stump shall be removed and the planting pit dug to a depth of 30 inches. If dug below 30 inches, compact the backfill to prevent settling. Large surface roots three feet from the outside circumference shall be removed, including the spoils and backfilled with City approved topsoil to grade and the area tamped to settle the soil.

4.2. PRUNING NEWLY PLANTED TREES

Young trees may be pruned to allow for proper growth through the years. If the tree is of high quality, it should need little pruning. It is no longer common practice to automatically trim a certain percentage of limbs from a newly planted tree. The tree needs as much foliage as can be available to assure rapid growth and solid leaf structure. This includes refraining from “limbing up” and topping. Pruning of newly planted or young trees shall be performed by or under the supervision of a certified arborist, or a landscape architect for newly planted trees.

4.2.1. Type of Pruning Prohibited

The following types of pruning techniques are prohibited on newly planted or young trees:

- a. The topping or pollarding of trees is strictly prohibited on all trees. When topping or pollarding occurs, tree replacement or other mitigation, as outlined in Subchapter 12 of the Unified Development Code, shall be required.
- b. Crown raising or “limbing up” trees (the practice of cutting the lowest branches to a desired height) shall be prohibited, unless otherwise approved by the City Forester. If approved by the City, all pruning shall be performed by or under the supervision of a certified arborist pursuant to the standards provided in Section 4.1.

4.2.2. Pruning guidelines (Recommended)

Scaffolding/ permanent branches. Identify the scaffolding/permanent branches. The lowest permanent branch should have a diameter of one-half or less of the trunk diameter where the branch attaches to the trunk. The vertical spacing of permanent

scaffold branches should equal a distance equal to 3% of the tree's eventual height. Thus, a tree that will be 50 feet tall should have permanent scaffold branches spaced about 18 inches apart along the trunk. Avoid allowing two scaffold branches to arise one above the other on the same side of the tree. Maintain radial balance with branches growing outward in each direction.

Illustration 4-6: Strong Scaffold Structure

From: International Society of Arboriculture - Trees Are Good (treesaregood.org)

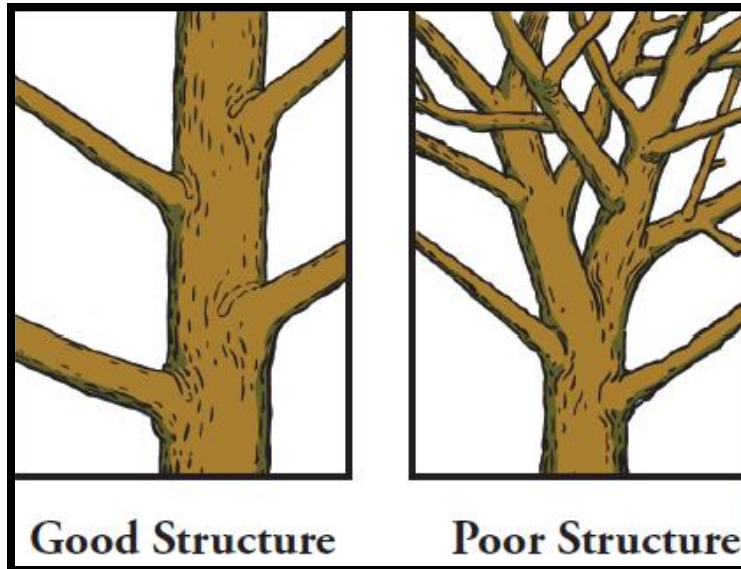

4.2.3. Limb removal (Recommended)

The following may be removed.

- a. Torn, damaged, dead branches. Remove the branch just outside of the branch collar. See Illustration 4-5.
- b. Double Leaders: Maintain a dominant trunk for at least six to eight feet without a major fork. If the trunk divides into two or more relatively equal stems, favor one strong stem and remove the others. Cut one stem back to a lateral branch.
- c. Rubbing branches: Eliminate branches that are rubbing or will soon rub against another branch.
- d. Crowding: Give each branch room to grow with minimal competition for sunlight. When possible, have major lateral branches evenly spaced eight to ten inches apart along the trunk. If the tree by its nature would lose too much foliage in the process of eliminating crowding, maintain at least half the foliage on branches in the lower 2/3 of the tree.
- e. Narrow Branch Angles/Included Bark: Remove one branch if the angle is 40% or narrower or if it appears that the bark from the branch is becoming pinched between the branch and the trunk.
- f. Sprouts and Suckers: Remove sprouts and suckers.
- g. Temporary branches: Leave temporary branches that are not competing with permanent, scaffolding branches.

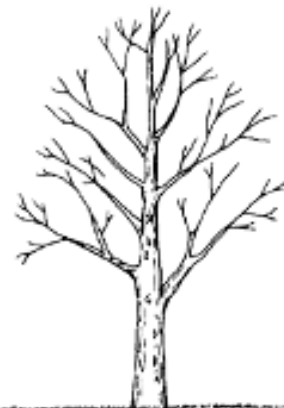

Select strong permanent scaffold branches that are spaced 12-18 inches apart.

SECTION 5: ADMINISTRATION, INSPECTION, AND ENFORCEMENT

5.1 ADMINISTRATION

The Ordinance and the standards in this Manual will be administered and updated by the City Arborist and/or Administrator.

5.2 INSPECTION

5.2.1. *Inspection by owner*

The project arborist or landscape architect retained by the applicant shall conduct the following required inspections of construction sites containing protected trees. Inspections shall verify that the type of tree protection and/or plantings are consistent with the standards outlined within this Manual. For each required inspection or meeting, a written summary of the changing tree related conditions and actions taken shall be provided to the City Forester.

- a. Pre-Construction Meeting. Prior to commencement of construction, the applicant or contractor shall conduct a pre-construction meeting to discuss tree protection with the job site superintendent, grading equipment operators, project arborist or landscape architect, and City Forester. At this time all tree protection fencing approved in the permit plans must be installed correctly.
- b. Inspection of Rough Grading. The project arborist or landscape architect shall perform an inspection during the course of rough grading adjacent to the CRZ to ensure trees will not be injured by compaction, cut or fill, drainage and trenching, and if required, inspect aeration systems, tree wells, drains and special paving. The contractor shall provide the City Forester at least 48 hours advance notice of such activity.
- c. Monthly Inspections. The project arborist or landscape architect shall perform monthly inspections to monitor changing conditions and tree health. The City Forester shall be in receipt of an inspection summary if there are any changes to the approved plans, tree health conditions, or protection measures. If the City Forester is not in receipt of inspection summaries prior to final inspection, the City will assume that no change in tree conditions have occurred in the field during construction.
- d. Special activity within the Critical Root Zone. Work in this area (CRZ) requires the direct onsite supervision of the project arborist or landscape architect.
- e. Landscape Architect and/or Project Arborist Inspection. Prior to the issuing of the certificate of occupancy in the City or acceptance of public infrastructure associated with a construction plan in the ETJ, the applicant or contractor shall contact the landscape architect and/or Project Arborist, as applicable, to perform an on-site inspection of all plant stock, quality of the materials and planting and that the irrigation is functioning consistent with the approved site or public infrastructure construction plans. The City shall be in receipt of a letter of compliance from the landscape architect or project arborist prior to scheduling the final inspection, unless otherwise approved.

5.2.2. *Inspection by City representative*

There are four types of inspections that may be performed by the City Forester and/or Administrator. They include the following:

- a. Site inspections during the site development plan, construction plan or preliminary plan review process.

- b. Tree fencing inspection and other tree preservation measures prior to construction, typically conducted at the time of erosion and sedimentation (E&S) preliminary inspection.
- c. Unscheduled site visits during construction.
- d. Final inspection.

5.3 ENFORCEMENT

The Subchapter 12 of UDC and the standards in this Manual are enforced by the City Forester and/or the Administrator, or their respective designees. Enforcement is described in Subchapter 11 and 12 of the Unified Development Code.

APPENDIX A: DEFINITIONS

For the purposes of this Manual the following definitions apply. Additional definitions may be found in the Ordinance.

Administrator (of the Tree Technical Manual) is the Assistant City Manager over Development Services, or their designee.

City Forester is an individual designated by the Administrator to oversee the City's urban forestry program and serve as an advisor to Development Services. In doing so, the City Forester or designee shall implement, administer, and oversee the provisions, terms and conditions of all aspects of public tree planting and the Public Tree Care Ordinance, and relevant provisions and procedures for tree preservation and landscaping throughout the development process. In the absence of a City Forester the powers and duties shall be the responsibility of the Administrator or their designee.

Certified Arborist is an individual who has demonstrated knowledge and competency through obtainment of the current International Society of Arboriculture arborist certification, or who is a member of the American Society of Consulting Arborists.

Dangerous tree see Hazardous tree.

Dead Tree means a tree that is dead or that has been damaged beyond repair or is in an advanced state of decline (where an insufficient amount of live tissue, green leaves, limbs or branches, exists to sustain life) and has been determined to be such by a certified arborist. If the tree has been determined to be dead, removal is permitted as defined in the ordinance.

Disturbance refers to all of the various activities from construction or development that may damage trees.

Dripline refers to the periphery of the area underneath a Tree that would be encompassed if perpendicular lines were dropped from the farthest edges of the crown of the tree.

Excessive Pruning means removing in excess, one-fourth (25 percent) or greater, of the functioning leaf, stem or root area. Pruning in excess of 25 percent is injurious to the tree and is a prohibited act. Excessive pruning typically results in the tree appearing as a 'bonsai', 'lion's-tailed', 'lolly-popped' or overly thinned.

- *Unbalanced Crown.* Excessive pruning also includes removal of the leaf or stem area predominantly on one side, topping, or excessive tree canopy or crown raising. Exceptions are when clearance from overhead utilities or public improvements is required or to abate a hazardous condition or a public nuisance.
- *Roots.* Excessive pruning may include the cutting of any root two (2) inches or greater in diameter and/or severing in excess of 25 percent of the roots.

Hazardous Tree refers to a tree that possesses a structural defect which poses an imminent risk if the tree or part of the tree that would fall on someone or something of value (target). Structural defect means any structural weakness or deformity of a tree or its parts. A tree with a structural defect can be verified to be hazardous by a certified arborist and confirmed as such by the City Forester. The City Forester retains discretionary right to approve or amend a hazardous rating, in writing, and recommend any action that may reduce the condition to a less-than significant level of hazard. If the tree has been determined to be hazardous, removal of the tree is permitted as provided for in the Subchapter 12 of the UDC.

Manual means this Tree Technical Manual: Standards and Specifications.

Project Arborist means a certified arborist retained by a property owner or development applicant for the purpose of overseeing on-site activity involving the welfare of the trees to be retained. The project arborist shall be responsible for all reports, appraisals, tree preservation plans, or inspections as required.

Protective Tree Fencing means a temporary enclosure erected around a tree to be protected at the boundary of the tree protection zone. The fence serves three primary functions: 1) to keep the foliage crown, branch structure and trunk clear from direct contact and damage by equipment, materials or disturbances; 2) to preserve roots and soil in an intact and non-compacted state; and 3) to identify the tree protection zone in which no soil disturbance is permitted and activities are restricted.

Root Buffer means a temporary layer of material to protect the soil texture and roots. The buffer shall consist of a base course of tree chips or mulch spread over the root area to a minimum of 6-inch depth.

Root Flare refers to the area where the trunk meets the roots and a significant amount of taper is visible. This area should never be covered by soil or mulch and should be visible after planting.

Site Plan means a set of drawings (e.g. preliminary drawings, site plan, grading, demolition, building, utilities, landscape, irrigation, tree survey, etc.) that show existing site conditions and proposed landscape improvements, including trees to be removed, relocated or to be retained. Site plans shall include the following minimum information that may impact trees:

- Surveyed tree location, species, size, dripline area (including trees located on neighboring property that overhang the project site) and protected trees within 30-feet of the project site.
- Paving, concrete, trenching or grade change located within the tree protection zone.
- Existing and proposed utility pathways.
- Surface and subsurface drainage and aeration systems to be used.
- Walls, tree wells, retaining walls and grade change barriers, both temporary and permanent.
- Landscaping, irrigation and lighting within dripline of trees, including all lines, valves, etc.
- Location of other landscaping and significant features.
- All of the final approved site plan sheets shall reference tree protection instructions.

Soil Compaction means the compression of soil particles that may result from the movement of heavy machinery and trucks, storage of construction materials, structures, paving, etc. within the tree protection zone. Soil compaction can result in atrophy of roots and potential death of the tree, with symptoms often taking 3 to 10-years to manifest.

Soil Fracturing means the loosening of hard or compacted soil around a tree by means of a pneumatic soil probe that delivers sudden bursts of air to crack, loosen or expand the soil to improve the root growing environment.

Target is a term used to include people, vehicles, structures or something subject to damage by a tree. Note: A tree may not be a hazard if a "target" is absent within the falling distance of a tree or its parts (e.g., a defective tree in a non-populated area away from pathways may not be considered a hazard)

Tree Damage (or Injury) means a wound resulting from any activity, including but not limited to 'excessive pruning', cutting, trenching, excavating, altering the grade, paving or compaction

within the tree protection zone of a tree. Injury shall include bruising, scarring, tearing or breaking of roots, bark, trunk, branches or foliage, herbicide or poisoning, or any other action foreseeable leading to the death or permanent damage to tree health.

Trenching means any excavation to provide irrigation, install foundations, utility lines, services, pipe, drainage or other property improvements below grade. Trenching within the CRZ is injurious to roots and tree health and is prohibited, unless approved. If trenching is approved within the CRZ, it must be in accordance with the instructions and table outlined in this Manual.

Tree Topping refers to the indiscriminate cutting of tree branches to stubs or lateral branches that are not large enough to assume the terminal role. Topping shall include 'heading', 'hat racking', and 'rounding over'.

Verification of Tree Protection means the project arborist shall verify, in writing, that all pre-construction conditions have been met (tree fencing, erosion control, pruning, etc.) and are in place. An initial inspection of protective fencing and written verification must be submitted to the City Arborist prior to demolition, grading or building permit issuance.

Vertical Mulching means augering, hydraulic or air excavation of vertical holes within a tree's root zone to loosen and aerate the soil, typically to mitigate compacted soil. Holes are typically penetrated 4- to 6-feet on center, 2- to 3-feet deep, 2- to 6-inches in diameter and backfilled with either perlite, vermiculite, peat moss or a mixture thereof.

APPENDIX B: BIBLIOGRAPHY

Sources Cited

- American Forests and National Association of Home Builders. Building Greener Neighborhoods. 2nd ed. Washington, DC: American Forests, 1998.
- Burditt Associates. Urban Forest Management Plan, City of College Station, Texas. Conroe, TX: Burditt Associates, 2002.
- Council of Tree and Landscape Appraisers. Guide for Plant Appraisal. 9th ed. Champaign, IL: International Society of Arboriculture, 2000.
- Dockter, Dave. Tree Technical Manual, Standards and Specifications. Palo Alto, CA: City of Palo Alto, Department of Planning and Community Development, 2001.
- Elmendorf, William. A Guide to Preserving Trees in Development Projects. University Park, PA: Pennsylvania State University, School of Forest Resources, 1999.
- Minnesota Department of Natural Resources, Division of Forestry. Conserving Wooded Areas in Developing Communities: Best Management Practices in Minnesota. St Paul, MN: Minnesota Department of Natural Resources, Division of Natural Resources, 1999.
- Peltier, Patrice and Gary W. Watson. "Transplanting Trees, Part 1: Preparing the Plant and Site for a Successful Move." Arbor Age January 2000: 8-15.
- Peltier, Patrice and Gary W. Watson. "Transplanting Trees, Part 2: Improve Your Tree Transplanting Survival Rates with These Transportation and Storage Tips." Arbor Age February 2000: 8-13.
- Peltier, Patrice and Gary W. Watson. "Transplanting Trees, Part 1: The "After Care" of Transplanting Trees Is the Most Critical Step." Arbor Age March 2000: 8-15.
- Seattle, Urban Forest Coalition. A City Among the Trees, An Urban Forestry Resource Guide. Seattle, WA: City of Seattle, 1998.
- TreeFolks. Tree Planting Guide. Austin, Texas: Tree Folks, 2000.
- Watson, Gary W. and E. B. Himelick. Principles and Practice of Planting Trees and Shrubs. Savoy, IL: International Society of Arboriculture, 1997.

Additional Resources

- American Nursery and Landscape Association. American Standard for Nursery Stock, ANSI Z60.1-2004. Washington, DC: American Nursery and Landscape Association, 2004.
- ANSI Z133.1-2006. American National Standards Institute Standard for Tree Care Operations—Pruning, Trimming, Repairing, Maintaining and Removing Trees, and Cutting Brush—Safety Standard.
- ANSI A300-2005. American National Standards Institute Standard for Tree Care Operations—Pruning, Trimming, Repairing, Maintaining, and Removing Trees and Cutting Brush—Standard Practice.

Clark, James R., Richard W. Harris and Nelda P. Matheny. Arboriculture Integrated Management of Landscape Trees, Shrubs, And Vines. 3rd ed. Upper Saddle River, NJ: Prentice Hall, 1999.

Gilman, Edward F. An Illustrated Guide to Pruning. 2nd ed. Albany, NY: Delmar, 2002.

Matheny, Nelda and James R. Clark. Trees and Development, A Technical Guide to Preservation of Trees During Land Development. Champaign, IL: International Society of Arboriculture, 1998.

Miller, Nancy L., David M. Rathke, and Gary R. Johnson. Protecting Trees from Construction Damage, A Homeowner's Guide. St. Paul, MN: University of Minnesota, Minnesota Extension Service, 1993.

Moll, Gary and Stanley Young. Growing Greener Cities A Tree-Planting Handbook. Venice, CA: Living Planet Press, 1992.

Pirone, Thomas P., John R. Hartman and Mary Ann Sall. Pirone's Tree Maintenance. 7th ed. Oxford, NY: Oxford University Press, 2000.

Shigo, Alex L. Tree Pruning A Worldwide Photo Guide. Durham, NH: Shigo and Trees, Associates, 1989.

Texas Association of Nurseryman. Grades and Standards. Austin, TX: Texas Association of Nurseryman, n.d.

TreePeople. The Simple Act of Planting a Tree: A Citizen Arborist's Guide to Healing Your Neighborhood, Your City, and Your World. Los Angeles, CA: Tarcher, 1990.

APPENDIX C: TREE PROTECTION CONSTRUCTION DETAILS

Table of Contents	
TP-01	Type I Tree Protection – (Standard) Chain-Link Fence
TP-02a	Type II Tree Protection – (Modified) Chain-Link Fence
TP-02b	Type II Tree Protection – (Modified) Chain-Link Fence
TP-03	Type III Tree Protection – (Modified) Wood Slats
TP-04	Tree Protection – Fence Locations (Misc.)
TP-05	Tree Protection – Warning Sign
TP-06	Tree Protection – Tree Wells
TP-07	Tree Protection – Trenching & Boring Standards
TP-08	Standard Tree Protection Notes

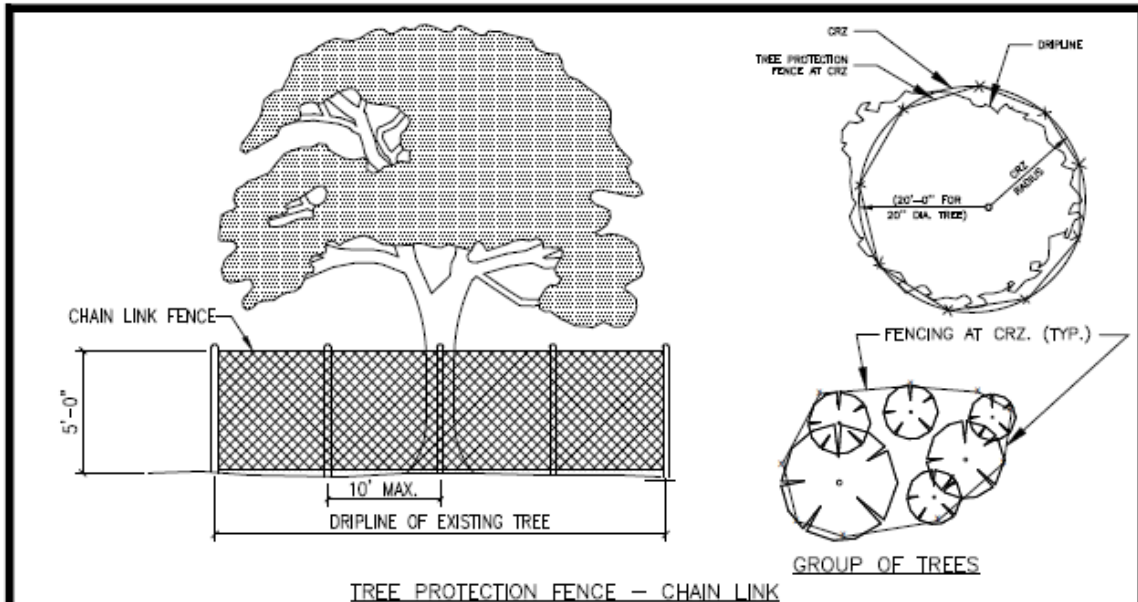

TREE PROTECTION FENCE – CHAIN LINK

NOTES:

1. TREE PROTECTION FENCES SHALL BE INSTALLED PRIOR TO THE COMMENCEMENT OF ANY SITE PREPARATION WORK (CLEARING, GRUBBING, OR GRADING) AND SHALL BE MAINTAINED THROUGHOUT ALL PHASES OF THE CONSTRUCTION PROJECT CONSISTENT WITH THE APPROVED PLAN.
2. EROSION AND SEDIMENTATION CONTROL BARRIERS SHALL BE INSTALLED AND MAINTAINED IN A MANNER WHICH DOES NOT RESULT IN TRENCHING OR SOIL BUILD-UP WITHIN A TREE'S CRZ OR DRIPLINES, WHICHEVER IS GREATER.
3. (STANDARD) TREE PROTECTION FENCES SHALL COMPLETELY SURROUND THE TREE OR CLUSTERS OF TREES AND BE PLACED AT THE OUTERMOST LIMITS OF THE TREE BRANCHES (DRIPLINE) OR CRZ, WHICHEVER IS GREATER; AND SHALL BE MAINTAINED THROUGHOUT THE CONSTRUCTION PROJECT IN ORDER TO PREVENT THE FOLLOWING:
 - A. SOIL COMPACTION IN ROOT ZONE AREA RESULTING FROM VEHICULAR TRAFFIC OR STORAGE OF EQUIPMENT OR MATERIALS.
 - B. ROOT ZONE DISTURBANCES DUE TO GRADE CHANGES (GREATER THAN SIX INCHES (6") CUT OR FILL) OR TRENCHING NOT REVIEWED AND AUTHORIZED BY THE CITY FORESTER OR ADMINISTRATOR.
 - C. WOUNDS TO EXPOSED ROOTS, TRUNKS, OR LIMBS BY MECHANICAL EQUIPMENT.
 - D. OTHER ACTIVITIES DETRIMENTAL TO TREES, SUCH AS CHEMICAL STORAGE, CONCRETE TRUCK CLEANING AND FIRES.
4. PARKING AREAS: IF THE FENCING MUST BE LOCATED ON PAVING OR SIDEWALK THAT WILL NOT BE DEMOLISHED, THE POSTS MAY BE SUPPORTED BY AN APPROPRIATE GRADE LEVEL CONCRETE BASE.
5. A WARNING SIGN SHALL BE PROMINENTLY DISPLAYED ON EACH FENCE. THE SIGN SHALL BE A MINIMUM OF 16 X 24 INCHES.

FOR QUESTIONS CONCERNING THIS DETAIL, PLEASE CONTACT THE DEVELOPMENT SERVICES CENTER.

ISSUE DATE:		CITY OF PFLUGERVILLE	DWG. #TP-01
REVISIONS			TP01.DWG
		TYPE I TREE PROTECTION – (STANDARD) CHAIN LINK FENCE	
DATE	APPROVED	DRAWN	
SCALE: N.T.S.		CONSTRUCTION STANDARDS AND DETAILS	

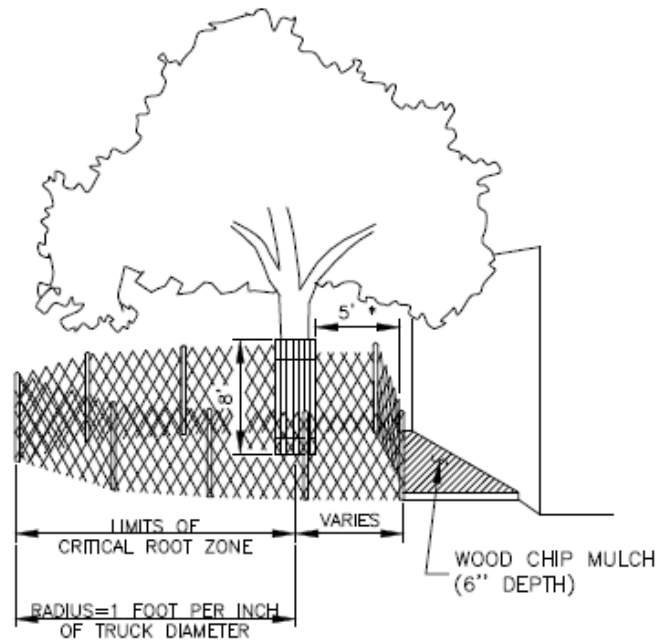

*AS NEEDED TO PROVIDE NECESSARY WORK SPACE. IF LESS THAN 5', THEN ADD BOARDS STRAPPED TO TRUNK.

NOTE:

LIMITS OF WOOD CHIP MULCH AREA AND DISTANCE FROM TRUNK TO WORK AREA SHALL BE SUBJECT TO THE APPROVAL OF THE CITY FORESTER.

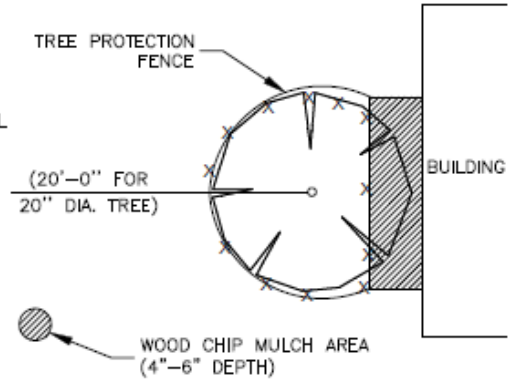

TREE PROTECTION FENCE (MODIFIED) – CHAIN LINK

FOR QUESTIONS CONCERNING THIS DETAIL, PLEASE CONTACT THE DEVELOPMENT SERVICES CENTER.

ISSUE DATE:		CITY OF PFLUGERVILLE	DWG. #TP-02a
REVISIONS			TP02a.DWG
		TYPE II TREE PROTECTION – (MODIFIED) CHAIN LINK FENCE	
DATE	APPROVED	DRAWN	
SCALE: N.T.S.			

TREE PROTECTION FENCE (MODIFIED) – CHAIN LINK
EXCEPTIONS

EXCEPTIONS TO FENCING ALONG THE CRZ:

1. IF APPROVED BY THE CITY FORESTER, EXCEPTIONS TO INSTALLING TREE FENCES AT THE TREE DISCIPLINES OR CRZ, WHICHEVER IS GREATER, MAY BE PERMITTED IN THE FOLLOWING CASES:
 - A. WHERE THERE IS TO BE AN APPROVED GRADE CHANGE, IMPERMEABLE PAVING SURFACE, OR TREE WELL.
 - B. WHERE PERMEABLE PAVING IS TO BE INSTALLED, ERECT THE FENCE AT THE OUTER LIMITS OF THE PERMEABLE PAVING AREA.
 - C. WHERE TREES ARE CLOSE TO PROPOSED BUILDINGS, ERECT THE FENCE NO CLOSER THAN SIX (6') FEET TO THE BUILDING, PROVIDED THAT THE FENCE DOES NOT ENCROACH INTO THE CRZ BY 50% MEASURED FROM THE BASE OF THE TREE, AND FENCING REMAINS A MINIMUM OF FIVE (5') FEET FROM THE BASE OF THE TREE.
 - D. WHERE THERE ARE SEVERE SPACE CONSTRAINTS DUE TO TRACT SIZE, OR OTHER SPECIAL REQUIREMENTS, CONTACT THE CITY FORESTER TO DISCUSS ALTERNATIVES.
2. WHERE ANY OF THE ABOVE EXCEPTIONS RESULT IN A FENCE THAT IS CLOSER THAN 5 FEET TO A TREE TRUNK, PROTECT THE TRUNK WITH STRAPPED-ON PLANKING TO A HEIGHT OF 8 FEET (OR TO THE LIMITS OF LOWER BRANCHING) IN ADDITION TO THE REDUCED FENCING.
3. WHERE ANY OF THE ABOVE EXCEPTIONS RESULT IN AREAS OF UNPROTECTED ROOT ZONES UNDER THE DRIPLINE OR CRZ, WHICHEVER IS GREATER, THOSE AREAS SHOULD BE COVERED WITH 4-6 INCHES OF ORGANIC MULCH TO MINIMIZE SOIL COMPACTION.
4. WHERE ANY OF THE ABOVE EXCEPTIONS RESULT IN DAMAGE TO THE FINE, WATER ABSORBING ROOTS, SUPPLEMENT WATERING SHALL BE REQUIRED:
 - A. TREES SHALL BE WATERED ONCE EVERY TWO WEEKS DURING PERIODS OF HOT, DRY WEATHER.
 - B. TREE CROWNS ARE TO BE SPRAYED WITH WATER TO REDUCE DUST ACCUMULATION ON LEAVES.
 - C. A SIGNED WATERING CONTRACT SHALL BE REQUIRED PRIOR TO THE START OF CONSTRUCTION.
5. PRIOR TO EXCAVATION OR GRADE CUTTING WITHIN TREE DRIPLINES, A CLEAN CUT SHALL BE MADE BETWEEN THE DISTURBED AND UNDISTURBED ROOT ZONES WITH A ROCK SAW OR SIMILAR EQUIPMENT TO MINIMIZE DAMAGE TO REMAINING ROOTS. THE CONTRACTOR SHALL CONTACT THE CITY FORESTER OR ADMINISTRATOR FOR SUPERVISION.
6. ALL GRADING WITHIN PROTECTED ROOT ZONES AREAS SHALL BE DONE BY HAND OR WITH SMALL EQUIPMENT TO MINIMIZE ROOT DAMAGE. PRIOR TO GRADING, RELOCATE PROTECTIVE FENCING TO TWO (2') FEET BEHIND THE GRADE CHANGE AREA.
7. A WARNING SIGN SHALL BE PROMINENTLY DISPLAYED ON EACH FENCE. THE SIGN SHALL BE A MINIMUM OF 16 X 24 INCHES.

FOR QUESTIONS CONCERNING THIS DETAIL, PLEASE CONTACT THE DEVELOPMENT SERVICES CENTER.

ISSUE DATE:	CITY OF PFLUGERVILLE	DWG. #TP-02b	
REVISIONS		TP02b.DWG	
	TYPE II TREE PROTECTION – (MODIFIED) CHAIN LINK FENCE		
DATE	APPROVED		DRAWN
SCALE: N.T.S.			
CONSTRUCTION STANDARDS AND DETAILS			

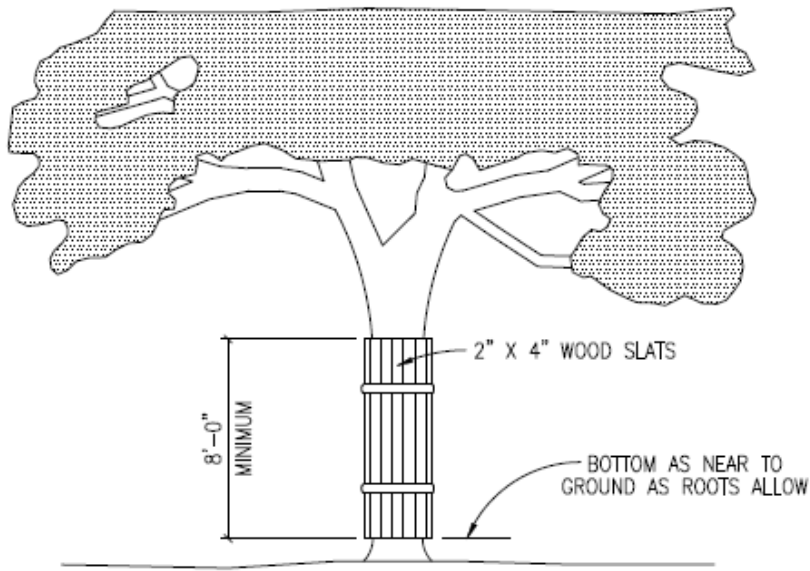

EXAMPLE OF BARK PROTECTION — DONE WHEN CRZ IS LESS THAN AN EIGHT (8') FOOT DIAMETER, UPON APPROVAL BY THE CITY FORESTER.

NOTES:

1. WHERE ANY EXCEPTIONS RESULT IN A FENCE BEING CLOSER THAN FIVE FEET (5'-0") TO A TREE TRUNK; PROTECT THE TRUNK WITH STRAPPED-ON-PLANKING TO A HEIGHT OF EIGHT FEET (8'-0"), OR TO THE LIMITS OF LOWER BRANCHING IN ADDITION TO THE REDUCED FENCING PROVIDED. MAJOR SCAFFOLD LIMBS MAY ALSO NEED PROTECTION AS DIRECTED BY THE CITY FORESTER.
2. TREES SITUATED IN A SMALL TREE WELL OR SIDEWALK PLANTER PIT, OR WHEN (ABOVE GROUND, NO GRADING OR TRENCHING WITHIN CRZ) CONSTRUCTION WILL COME WITHIN FIVE (5') FEET OF A TRUNK, SHALL HAVE THE TRUNK PROTECTED WITH STRAPPED-ON PLANKING TO A HEIGHT OF EIGHT (8') FEET OR TO THE LIMITS OF LOWER BRANCHES. MAJOR SCAFFOLD LIMBS MAY ALSO NEED PROTECTION AS DIRECTED BY THE CITY FORESTER.

FOR QUESTIONS CONCERNING THIS DETAIL, PLEASE CONTACT THE DEVELOPMENT SERVICES CENTER.

ISSUE DATE:		CITY OF PFLUGERVILLE	DWG. #TP-03
REVISIONS			TP03.DWG
		TYPE III TREE PROTECTION - (MODIFIED) WOOD SLATS	
DATE	APPROVED	DRAWN	
SCALE: N.T.S.			
CONSTRUCTION STANDARDS AND DETAILS			

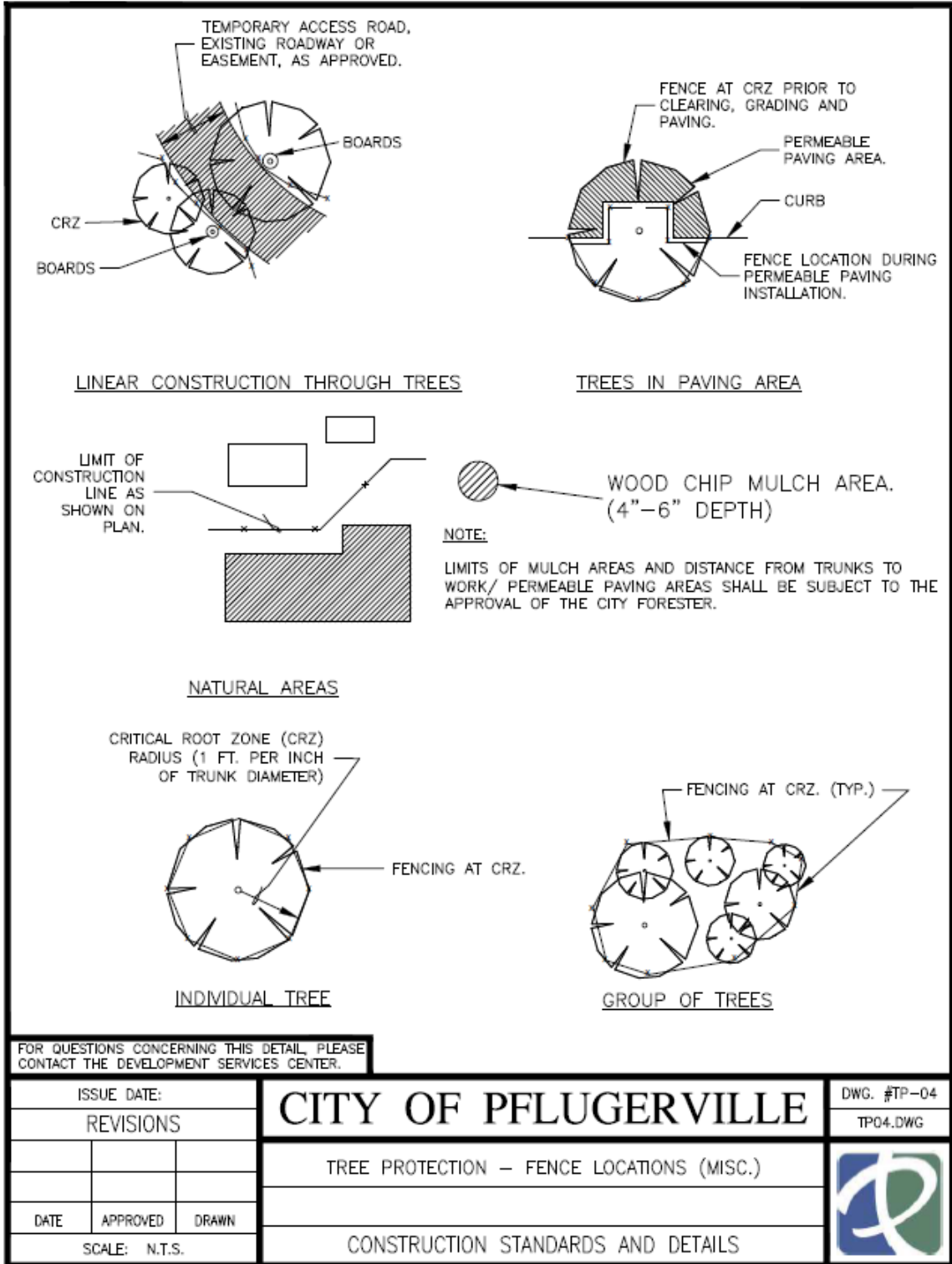

Sign Verbiage

WARNING
 -CRITICAL ROOT ZONE-
 ENCROACHMENT MAY RESULT IN
 PERMANENT TREE DAMAGE, RESULTING
 IN TREE REPLACEMENT.

¡ADVERTENCIA!
 -ZONA DE RAÍZ CRÍTICA-
 LA INVASIÓN PUEDE OCASIONAR DAÑOS
 PERMANENTES A LOS ÁRBOLES, EL
 RESULTADO ES EL REEMPLAZO DE LOS
 ÁRBOLES.

WARNING SIGN PLACEMENT

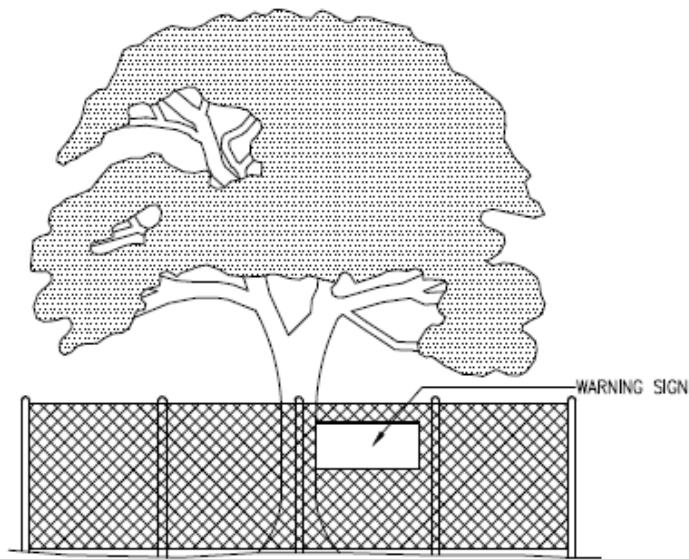

NOTES:

1. A WARNING SIGN SHALL BE PROMINENTLY DISPLAYED ON EACH FENCE. THE SIGN SHALL BE A MINIMUM OF 16 X 24 INCHES.

FOR QUESTIONS CONCERNING THIS DETAIL, PLEASE CONTACT THE DEVELOPMENT SERVICES CENTER.

ISSUE DATE:			CITY OF PFLUGERVILLE	DWG. #TP-05
REVISIONS				TP05.DWG
			TREE PROTECTION - WARNING SIGN	
DATE	APPROVED	DRAWN		
SCALE: N.T.S.			CONSTRUCTION STANDARDS AND DETAILS	

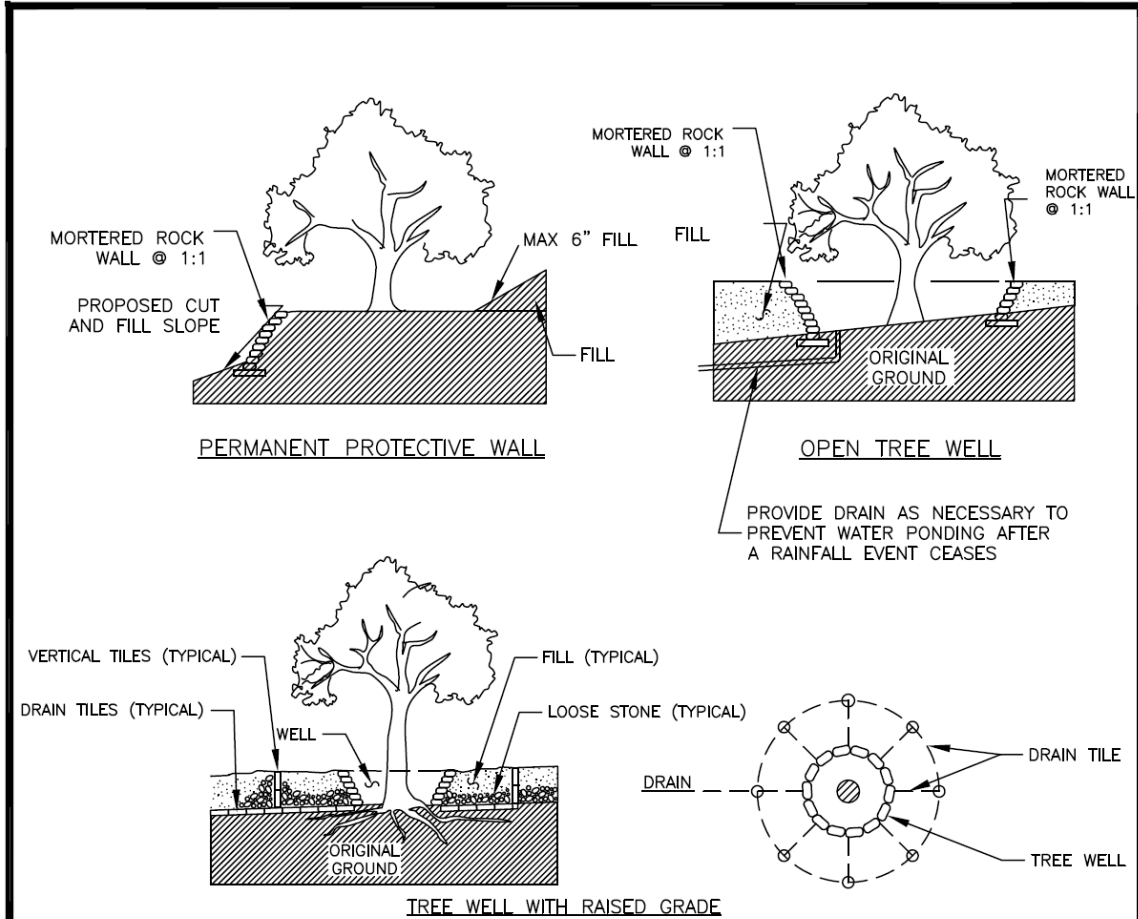

- NOTES:
1. LOCATION, TYPE, DEPTHS AND CONSTRUCTION SPECIFICATIONS OF FILL, DRAINS AND WALLS SHALL BE SUBJECT TO THE APPROVAL OF THE CITY FORESTER.
 2. GRADE CHANGES WITHIN THE CRZ ARE NOT NORMALLY PERMITTED.
 3. IF GRADING WITHIN THE CRZ IS APPROVED, GRADING SHALL BE DONE BY HAND OR WITH SMALL EQUIPMENT TO MINIMIZE ROOT DAMAGE.
 4. GRADE CHANGES OUTSIDE THE CRZ SHALL NOT SIGNIFICANTLY ALTER DRAINAGE TO THE TREE.
 5. GRADE CHANGES UNDER SPECIFICALLY APPROVED CIRCUMSTANCES SHALL NOT ALLOW MORE THAN SIX (6") INCHES OF FILL SOIL ADDED OR ALLOW MORE THAN SIX (6") INCHES OF EXISTING SOIL TO BE REMOVED FROM NATURAL GRADE UNLESS MITIGATED.
 6. GRADE FILLS OVER SIX (6") INCHES OR IMPERVIOUS OVERLAY SHALL INCORPORATE AN APPROVED PERMANENT AERATION SYSTEM, PERMEABLE MATERIAL OR OTHER APPROVED MITIGATION.
 7. GRADE CUTS EXCEEDING SIX (6") INCHES SHALL INCORPORATE RETAINING WALLS OR AN APPROPRIATE TRANSITION EQUIVALENT.

FOR QUESTIONS CONCERNING THIS DETAIL, PLEASE CONTACT THE DEVELOPMENT SERVICES CENTER.

ISSUE DATE:	CITY OF PFLUGERVILLE	DWG. #TP-06
REVISIONS	TREE PROTECTION – TREE WELLS	TP06.DWG
DATE APPROVED DRAWN	CONSTRUCTION STANDARDS AND DETAILS	
SCALE: N.T.S.		

TRENCHING LIMITATIONS IN CRZ – DISTANCE FROM BASE OF TREE



NO TRENCHING SHALL OCCUR WITHIN THE CRITICAL ROOT ZONE (CRZ) UNLESS OTHERWISE APPROVED BY THE CITY. HOWEVER, TRENCHING SHALL NOT OCCUR WITHIN FIFTY (50%) PERCENT OF THE CRZ MEASURED FROM THE BASE OF THE TREE OR WITHIN FIVE (5') FEET FROM THE BASE OF THE TREE. THE CRITICAL ROOT ZONE (CRZ) SHALL BE MEASURED ONE (1') FOOT OF RADIAL DISTANCE FOR EVERY INCH OF TREE DIAMETER AT BREAST HEIGHT (DBH).

NO TRENCHING WITHIN 50% OF CRZ

MIN. 5-FEET DISTANCE FROM BASE OF TREE

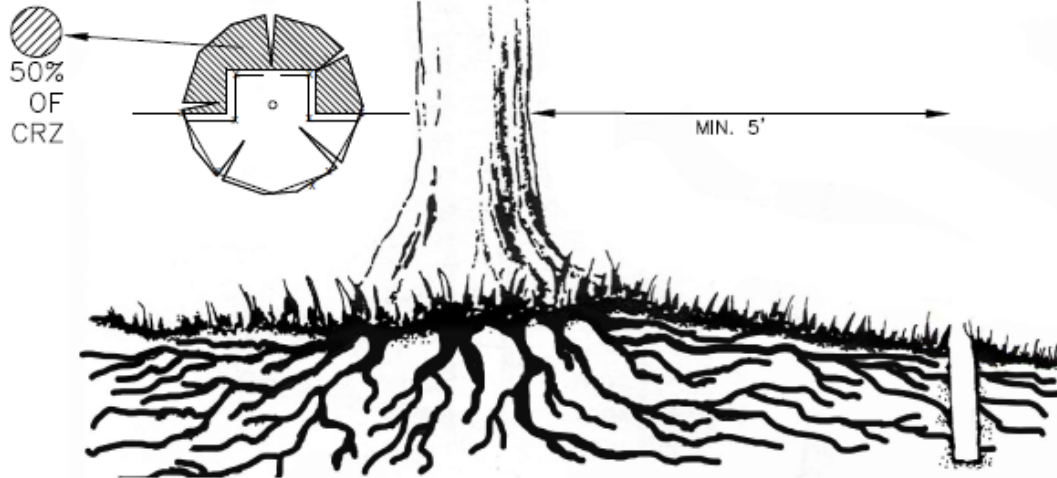

WHEN TRENCHING IS NOT PERMITTED, BORING (TUNNELING) WILL BE AN ACCEPTABLE ALTERNATIVE PURSUANT TO THE TUNNELING DEPTH REQUIREMENTS BASED ON THE RESPECTIVE TREE DIAMETERS (DBH) PROVIDED BELOW.

DEPTH OF TUNNEL BORING – WITHIN CRZ

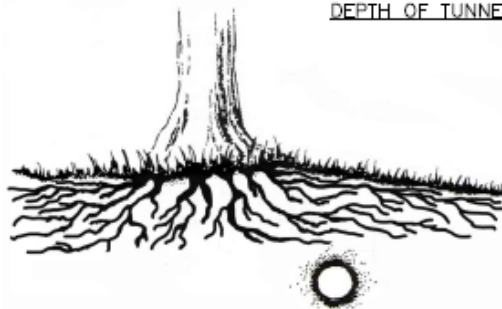

DEPTH OF TUNNEL BORING



9" DBH OR LESS	2.5' DEPTH OF BORE
10-14" DBH	3' DEPTH OF BORE
15-19" DBH	3.5' DEPTH OF BORE
MORE THAN 19" DBH	4.0' DEPTH OF BORE

DBH = TREE DIAMETER AT BREAST HEIGHT

FOR QUESTIONS CONCERNING THIS DETAIL, PLEASE CONTACT THE DEVELOPMENT SERVICES CENTER.

ISSUE DATE:	CITY OF PFLUGERVILLE	DWG. #TP-07	
REVISIONS		TP07.DWG	
	TREE PROTECTION – TRENCHING & BORING STANDARDS		
DATE	APPROVED		DRAWN
SCALE: N.T.S.	CONSTRUCTION STANDARDS AND DETAILS		

STANDARD TREE PROTECTION NOTES:

1. ALL TREES NOT LOCATED WITHIN THE LIMITS OF CONSTRUCTION AND OUTSIDE OF DISTURBED AREAS SHALL BE PRESERVED.
2. ALL TREES SHOWN ON THIS PLAN TO BE RETAINED SHALL BE PROTECTED DURING CONSTRUCTION WITH FENCING CONSISTENT WITH THE CITY'S CONSTRUCTION DETAIL(S).
3. TREE PROTECTION FENCES SHALL BE ERECTED ACCORDING TO CITY STANDARDS FOR TREE PROTECTION, FENCE MATERIAL, AND FENCE SIGNAGE.
4. TREE PROTECTION FENCES SHALL BE INSTALLED PRIOR TO THE COMMENCEMENT OF ANY SITE PREPARATION WORK (CLEARING, GRUBBING, OR GRADING) AND SHALL BE MAINTAINED THROUGHOUT ALL PHASES OF THE CONSTRUCTION PROJECT CONSISTENT WITH THE APPROVED PLAN. TREE PROTECTION FENCES SHALL COMPLETELY SURROUND THE TREE OR CLUSTERS OF TREES AND BE PLACED AT THE OUTERMOST LIMITS OF THE TREE BRANCHES (DRIPLINE) OR CRZ, WHICHEVER IS GREATER.
5. EROSION AND SEDIMENTATION CONTROL BARRIERS SHALL BE INSTALLED AND MAINTAINED IN A MANNER WHICH DOES NOT RESULT IN TRENCHING OR SOIL BUILD-UP WITHIN A TREE'S CRZ OR DRIPLINES, WHICHEVER IS GREATER.
6. ANY ROOTS EXPOSED BY CONSTRUCTION ACTIVITY SHALL BE PRUNED FLUSH WITH THE SOIL BACKFILL ROOT AREAS WITH GOOD QUALITY TOP SOIL AS SOON AS POSSIBLE. IF EXPOSED ROOT AREAS ARE NOT BACKFILLED WITHIN TWO (2) DAYS, COVER THEM WITH ORGANIC MATERIAL IN A MANNER WHICH REDUCES SOIL TEMPERATURE AND MINIMIZES WATER LOSS DUE TO EVAPORATION.
7. WHEN CONSTRUCTION OCCURS IMMEDIATELY OUTSIDE OF THE CRZ OR DRIPLINE OF A PRESERVED TREE, A CLEAN CUT SHALL BE MADE BETWEEN THE DISTURBED AND UNDISTURBED ROOT ZONES WITH A ROCK SAW OR SIMILAR EQUIPMENT PRIOR TO EXCAVATION OR GRADE CUTTING. THE PURPOSE OF THIS PROVISION IS TO MINIMIZE DAMAGE TO THE REMAINING ROOTS OF PRESERVED TREES. THE CONTRACTOR SHALL CONTACT THE CITY FORESTER OR ADMINISTRATOR FOR SUPERVISION.
8. WHEN INSTALLING CONCRETE ADJACENT TO THE ROOT ZONE OF A TREE, USE A PLASTIC VAPOR BARRIER BEHIND THE CONCRETE TO PROHIBIT LEACHING OF LIME INTO THE ROOT ZONE.
9. ANY TRENCHING SHALL BE AS FAR FROM EXISTING TREE TRUNKS AS POSSIBLE. TRENCH LINES SHALL NOT RUN WITHIN THE CRZ. BORING, TUNNELING OR OTHER TECHNIQUES MAY BE APPROVED BY THE CITY FORESTER OR ADMINISTRATOR IF THERE ARE NO OTHER ALTERNATIVES AVAILABLE. REFER TO TREE PROTECTION DETAIL - TRENCHING AND BORING STANDARDS.
10. NO LANDSCAPE TOPSOIL DRESSING GREATER THAN SIX (6") INCHES SHALL BE PERMITTED WITHIN THE DRIPLINE OR CRZ, WHICHEVER IS GREATER, OF TREES. NO TOPSOIL IS PERMITTED ON ROOT FLARES OR WITHIN SIX (6") INCHES OF TREE TRUNKS.
11. TREES MOST HEAVILY IMPACTED BY CONSTRUCTION ACTIVITIES SHALL BE WATERED DEEPLY ONCE A WEEK DURING PERIODS OF HOT, DRY WEATHER. TREE CROWNS SHALL BE SPRAYED WITH WATER PERIODICALLY TO REDUCE DUST ACCUMULATION ON THE LEAVES.
12. PRUNING TO PROVIDE CLEARANCE FOR STRUCTURES, VEHICULAR TRAFFIC AND CONSTRUCTION EQUIPMENT SHALL TAKE PLACE BEFORE CONSTRUCTION BEGINS. ALL PRUNING MUST BE DONE ACCORDING TO CITY STANDARDS PURSUANT TO SECTION 4 OF THE TREE TECHNICAL MANUAL AND AS OUTLINED IN LITERATURE PROVIDED BY THE INTERNATIONAL SOCIETY OF ARBORICULTURE (ISA PRUNING TECHNIQUES).
13. ALL OAK TREE CUTS, INTENTIONAL OR UNINTENTIONAL, SHALL BE PAINTED IMMEDIATELY (WITHIN 10 MINUTES). TREE PAINT MUST BE KEPT ON SITE AT ALL TIMES. ALL PRUNING OR CUTTING TOOLS MUST BE STERILIZED BETWEEN TREES TO PREVENT THE SPREAD OF DISEASE.
14. TREES APPROVED FOR REMOVAL SHALL BE REMOVED IN A MANNER WHICH DOES NOT IMPACT TREES TO BE PRESERVED. REFER TO THE CITY OF PFLUGERVILLE TREE TECHNICAL MANUAL FOR APPROPRIATE REMOVAL METHODS.
15. DEVIATIONS FROM THE ABOVE NOTES ARE CONSIDERED ORDINANCE VIOLATIONS IF THERE IS SUBSTANTIAL NONCOMPLIANCE OR IF A TREE SUSTAINS DAMAGE AS A RESULT.
16. (PRE-CONSTRUCTION CONFERENCE) THE DEMOLITION, GRADING AND UNDERGROUND CONTRACTORS, CONSTRUCTION SUPERINTENDENT AND OTHER PERTINENT PERSONNEL ARE REQUIRED TO MEET WITH THE CITY FORESTER AND/OR ADMINISTRATOR PRIOR TO BEGINNING WORK TO REVIEW PROCEDURES, TREE PROTECTION MEASURES AND TO ESTABLISH HAUL ROUTES, STAGING AREAS, CONTACTS, WATERING, ETC.
17. (VERIFICATION OF TREE PROTECTION) THE PROJECT ARBORIST, LANDSCAPE ARCHITECT OR CONTRACTOR SHALL VERIFY, IN WRITING, THAT ALL PRECONSTRUCTION CONDITIONS HAVE BEEN MET (TREE FENCING, EROSION CONTROL, PRUNING, ETC.) AND ARE IN PLACE. WRITTEN VERIFICATION MUST BE SUBMITTED TO AND APPROVED BY THE CITY FORESTER OR THE ADMINISTRATOR BEFORE DEMOLITION OR GRADING BEGINS.

FOR QUESTIONS CONCERNING THIS DETAIL, PLEASE CONTACT THE DEVELOPMENT SERVICES CENTER.

ISSUE DATE:		CITY OF PFLUGERVILLE	DWG. #TP-08
REVISIONS			TP08.DWG
		STANDARD TREE PROTECTION NOTES	
DATE	APPROVED	DRAWN	
SCALE: N.T.S.		CONSTRUCTION STANDARDS AND DETAILS	